

# A General Intro to Climbing in China

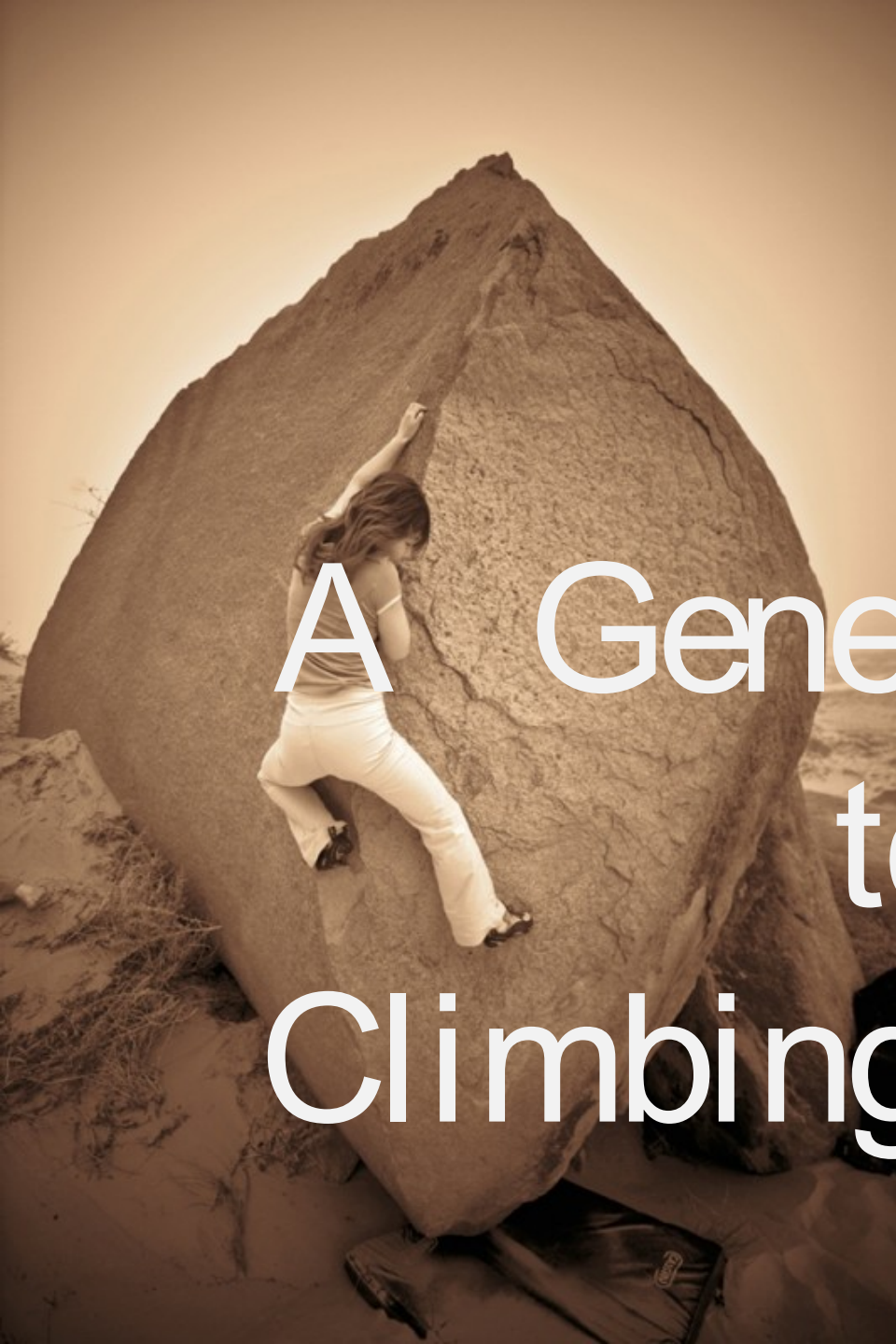

# Brief Chronicle of Climbing

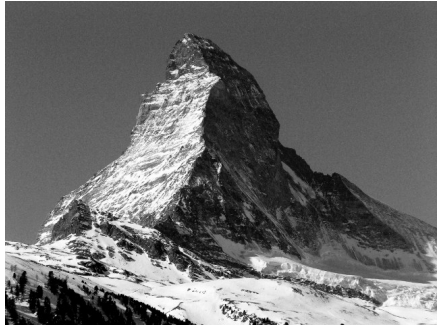

Alps, modern climbing started



Eiger, north face; Himalaya



Mt Everest

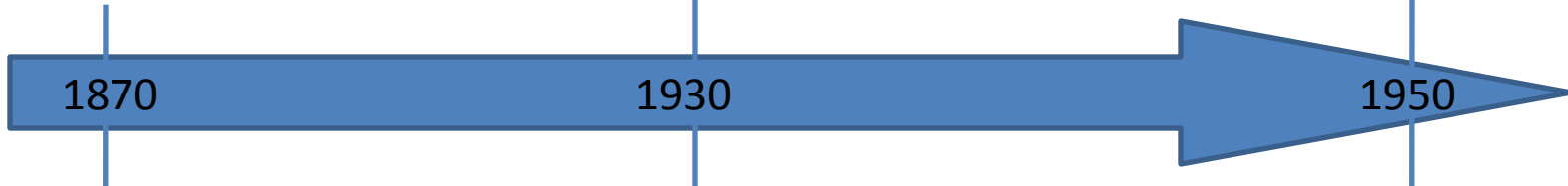

Climbing Started in China

Suffering from Qing Dynasty, invasion of western countries

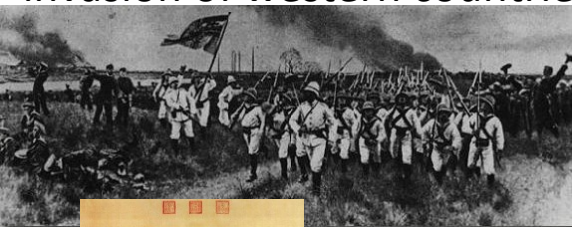

Japan invaded Asia



P.R.C



People started climbing late

Not popular

No world-class climber (except the Tibetan 14K team)

# Why do we talk about China?



# The Home of Mountains

7 of 14 Eight Thousanders (the highest peaks)







# Piolet d'Or

4 climbs in 19 since 1991, 21%



# History



# 1st Generation



在当时国际帝修反的一片反华叫嚣声中，在三年自然灾害和功修背信弃义单方面退出中苏两国登山运动员共同攀登珠峰的活动的时候，中国登山运动员这次从北坡首次成功地登上珠峰的胜利，充分显示了中国人民在中国共产党和毛主席的领导下，无高不可攀、无坚不可摧，吓不倒压不垮的革命英雄主义精神。

--We beat the disloyal Soviet Union, we beat our enemy USA, we beat the natural disaster. It shows our bravery, long-live Chairman Mao, long-live P.R.C

- May 25th ,1960
- June 13th ,1957 Minya Re

~~Ego?~~

Honor Sacrifice



politics

up climbing

ty

government

## 2nd Generation



1980s-1990s

“7+2 dream”

Interests is switched to “satisfying climber’ ego”

International view

No pushing from politics

CMA(China Mountaineering Association)  
personal interest is seen

it is goal-driven; as individual, no



# 3rd Generation

21th Century



Education

Peking University  
Master in USA

Peking University

Ice

WI 7 >M8

WI6

Rock

5.13-

5.12+

Mountain

N/A

Mt .Everest, Alpinism

CMA

In-System Climber

V.S.

Free Climber



# 1. 谢卫成 / Achen Professionals

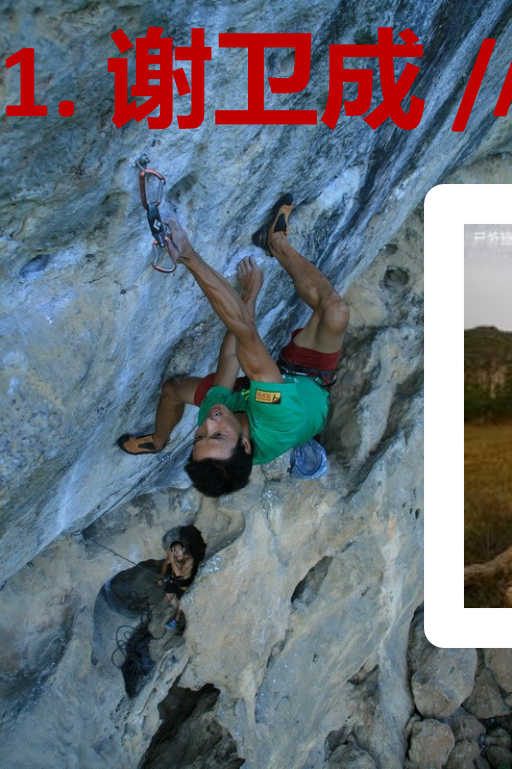

8C/ 5.14b

The big-brother in Chinese sport climbers

Route setter



# 2. 严冬冬 / Dongdong

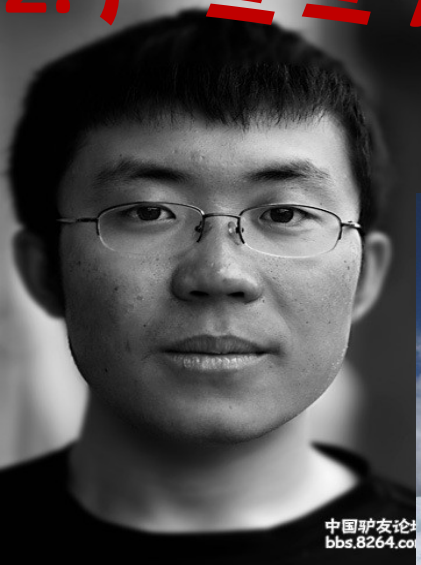

- TNF sponsored athlete
- First ascent ,south face of Five-Color-Mountain
- Winter ascent Ningjinkansa (7206m)
- Establish “the free spirits” route on Siguniang
- Nominee Piolet d’Or 2010



# Piolets d'Or

4 climbs in 19 since 1991, 21%





# Dilemmas for professionals

- ❖ Incoming

  - ❖ Climb harder , risk more

    - ❖ Pressure from CMA

# Free climber community in Beijing ----“the White-River Gang”

The White-river Climbing Fund  
The toughest trad climbers in China  
All-rounders  
Climbers all with high education  
The middle class  
International vision



M8, WI 4+

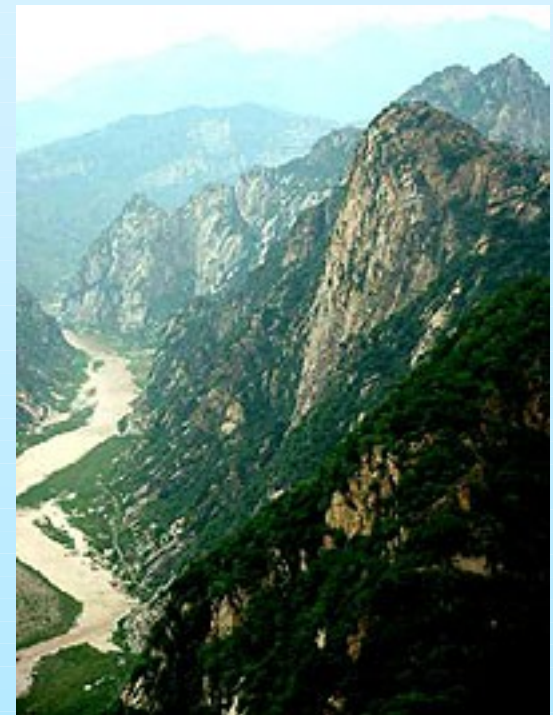

bolted, trad, bouldering  
5.13+

# History

- Politics----Ego----Enjoying climbing
- Himalaya----All disciplines
- CMA---Professional----Free climber



# Geography



Potentials Potentials Potentials Potentials Potentials Potentials Potentials Potentials

**Unlimited Potentials in China in terms of natural resources**



# CHINA



1 : 3 200 000

KLETT-PERTHES



# 中国三级地势示意图

0 400 800 千米

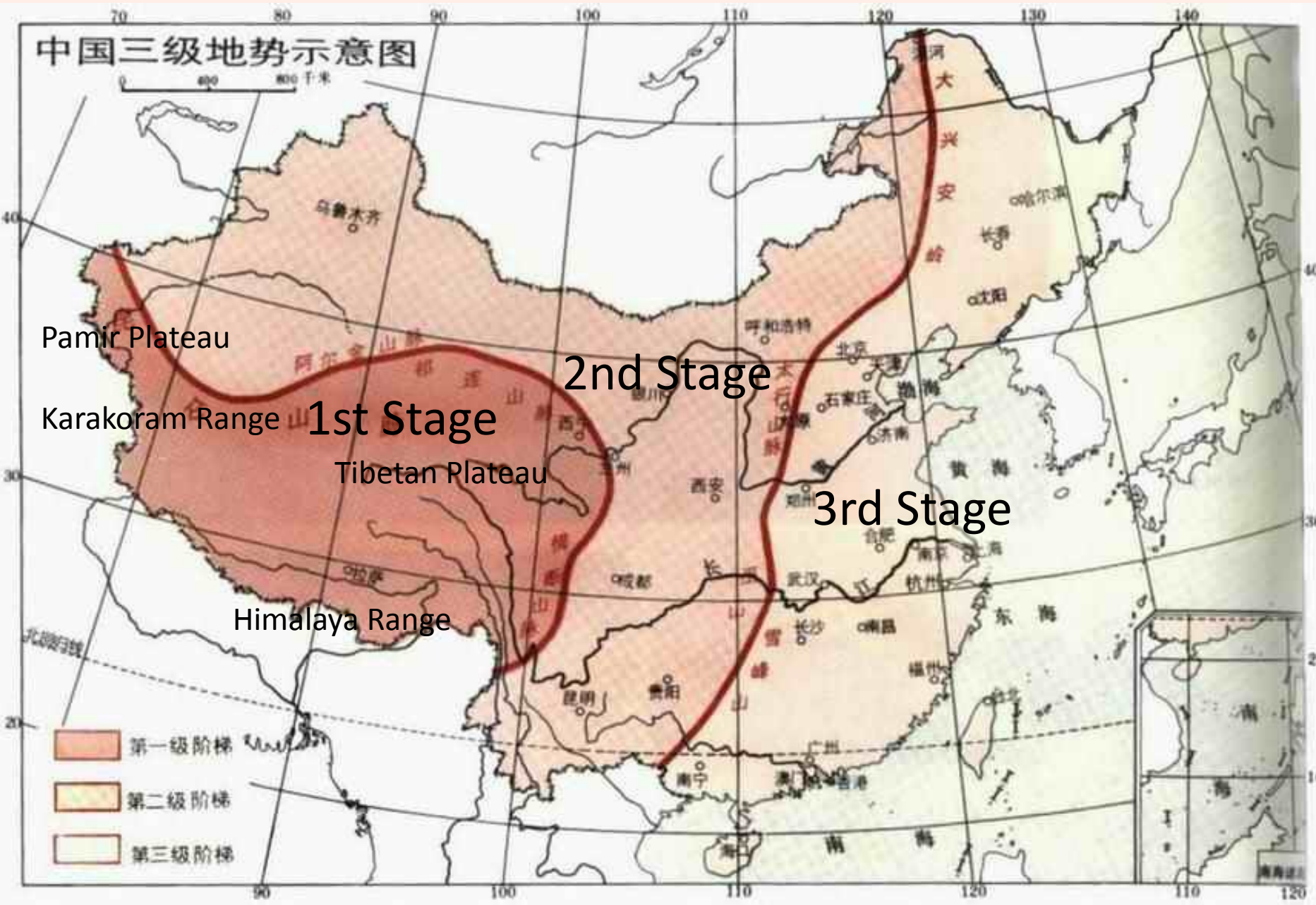

Pamir Plateau

Karakoram Range

1st Stage

Tibetan Plateau

Himalaya Range

2nd Stage

3rd Stage

- 第一级阶梯
- 第二级阶梯
- 第三级阶梯

**By Disciplines**



# Mountaineering

中国三级地势示意图

7000m+ Gongir, Gongirjoebeer, Muztagata



TIME: one-way(DAY)

Flight -1

Train -1

Car --1

Donkey---1

climbing period—15-20

5,000m=16,000ft

6,000m=20,000ft

7,000m=23,000ft

8,000m=26,000ft

6000m+ Gurla Mandhata, or Naimona'nyi



Flight -1, Car 3, climbing period 6

6000m Dang La, Kunlun  
Kekexili NP

Flight 1, car 1, climbing period 2-4

6000~8000m+, Cho Oyo, Ningjinkansa, Tsangzi

TIME: one-way(DAY)

Flight -1 一级阶梯

Car --1 二级阶梯

climbing period—15-20 第三级阶梯

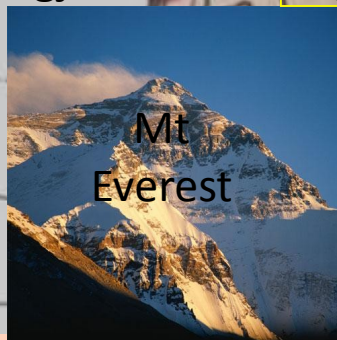

6000m+ Gnyan chen thang lha  
The most popular area

Flight 1, car 1, yak 1, climbing period 2-5

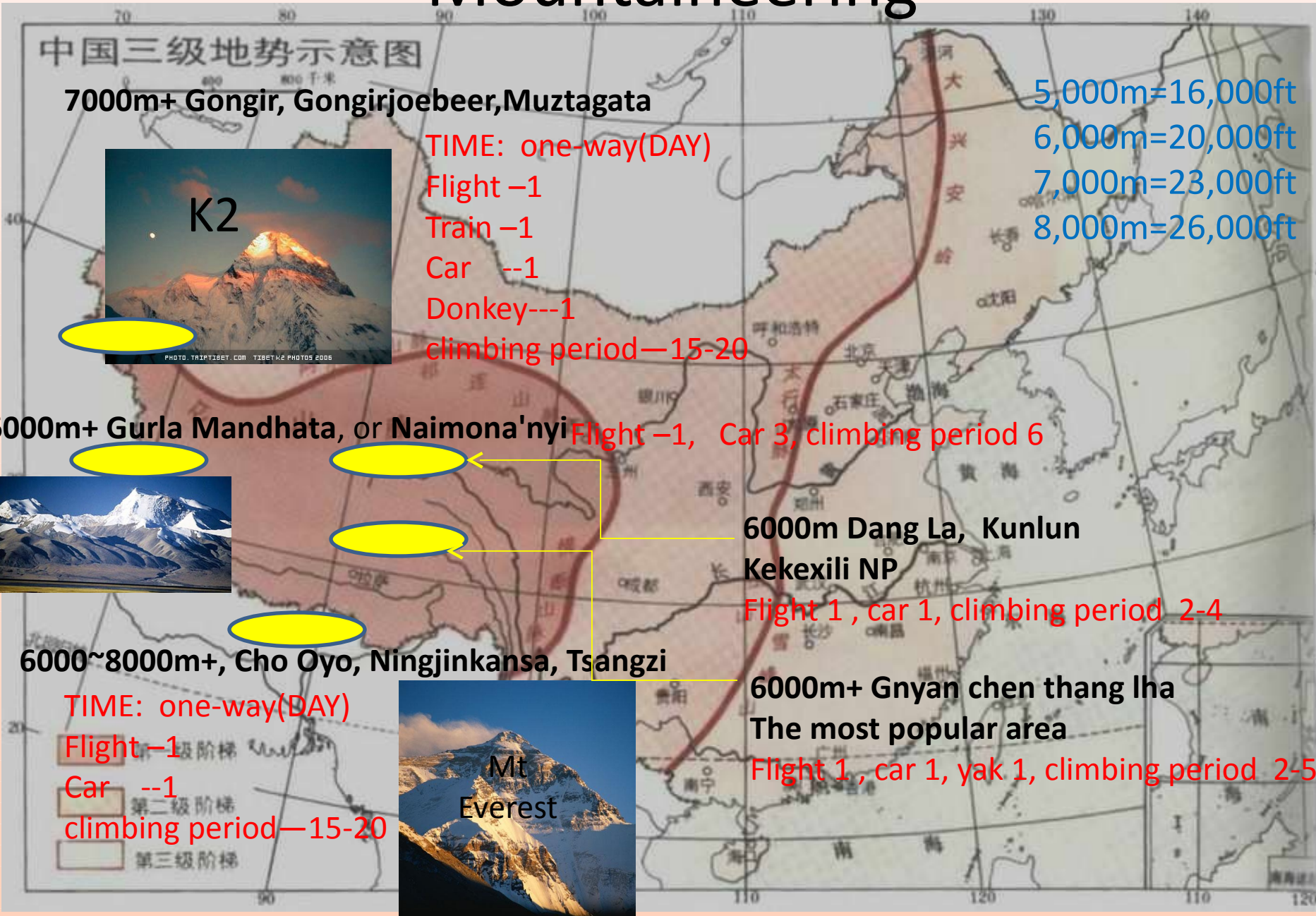

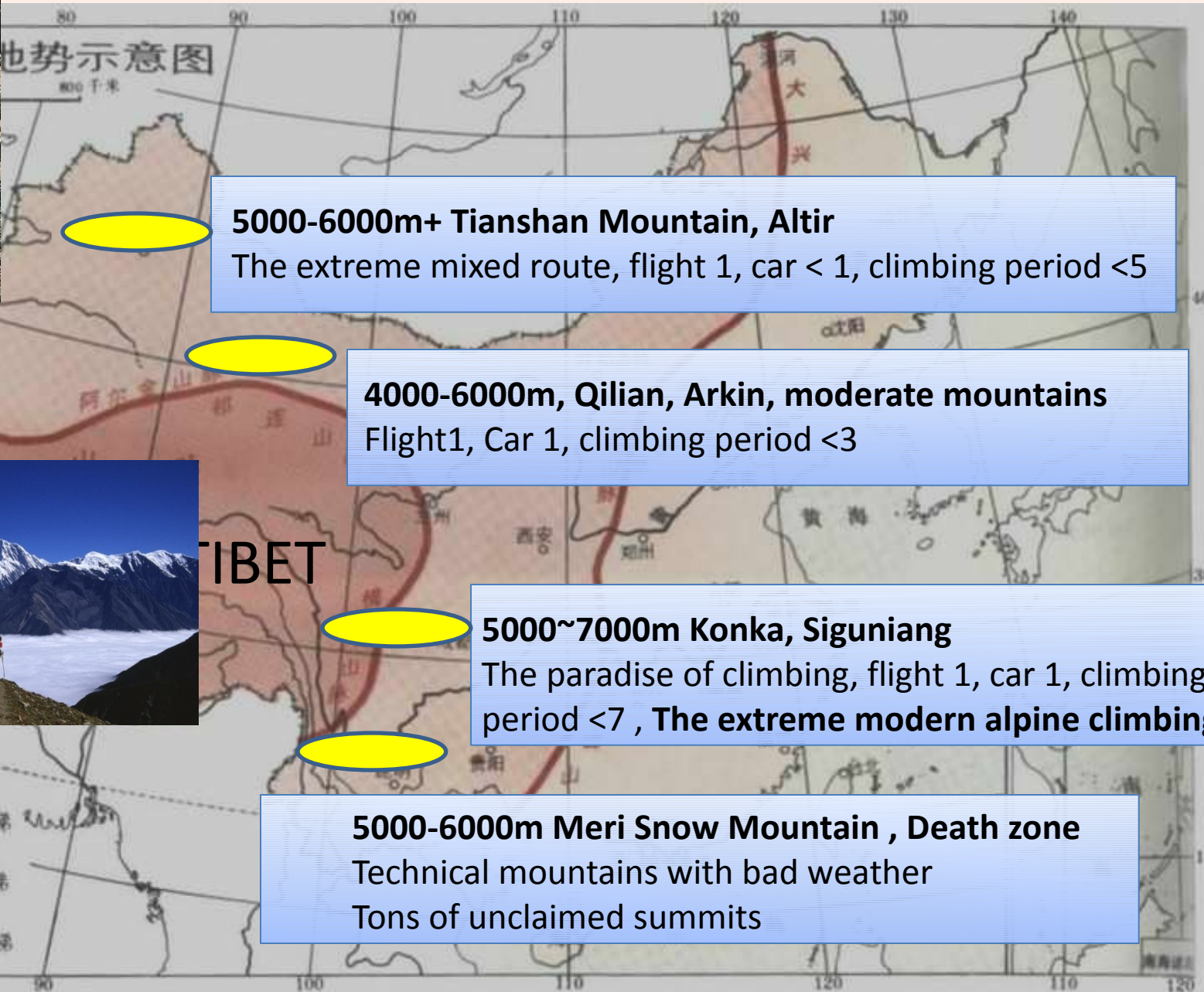

**5000-6000m+ Tianshan Mountain, Altir**  
The extreme mixed route, flight 1, car < 1, climbing period <5



**4000-6000m, Qilian, Arkin, moderate mountains**  
Flight1, Car 1, climbing period <3



TIBET

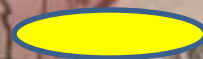

**5000~7000m Konka, Siguniang**  
The paradise of climbing, flight 1, car 1, climbing period <7 , **The extreme modern alpine climbing**



**5000-6000m Meri Snow Mountain , Death zone**  
Technical mountains with bad weather  
Tons of unclaimed summits

- 第一级阶梯
- 第二级阶梯
- 第三级阶梯



# Characterization of the climb

Avoid summer and winter  
Grass land, rock & ice

Season : avoid June to Sep  
Few vegetation, rock & ice,  
long hiking (multi days)

Avoid June to Sep, lots of vegetation,  
extreme route, ice, snow, rock, big wall

Season : late Apr --early June, Sep—Oct  
Few vegetation, more ice and snow

- 
- 第一级阶梯
  - 第二级阶梯
  - 第三级阶梯

# Characterization of the climb

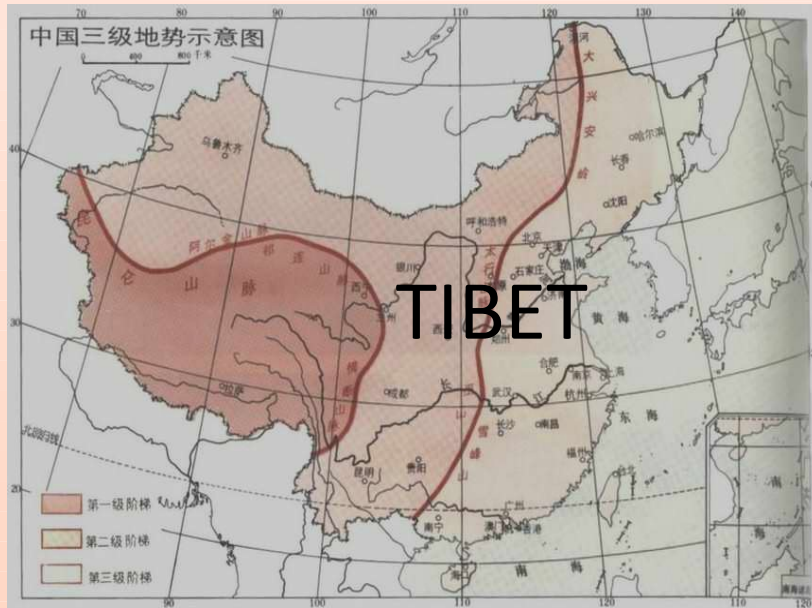

- Dry
- Little oxygen
- Few vegetation
- Hard to access
- Long climbing period
- Limited aging





PHOTO 紫笛依扬  
[www.zidiyyang.fotoyard.com](http://www.zidiyyang.fotoyard.com)



By 王巨士





By 王巨士



By 王巨士



# Characterization of the climb

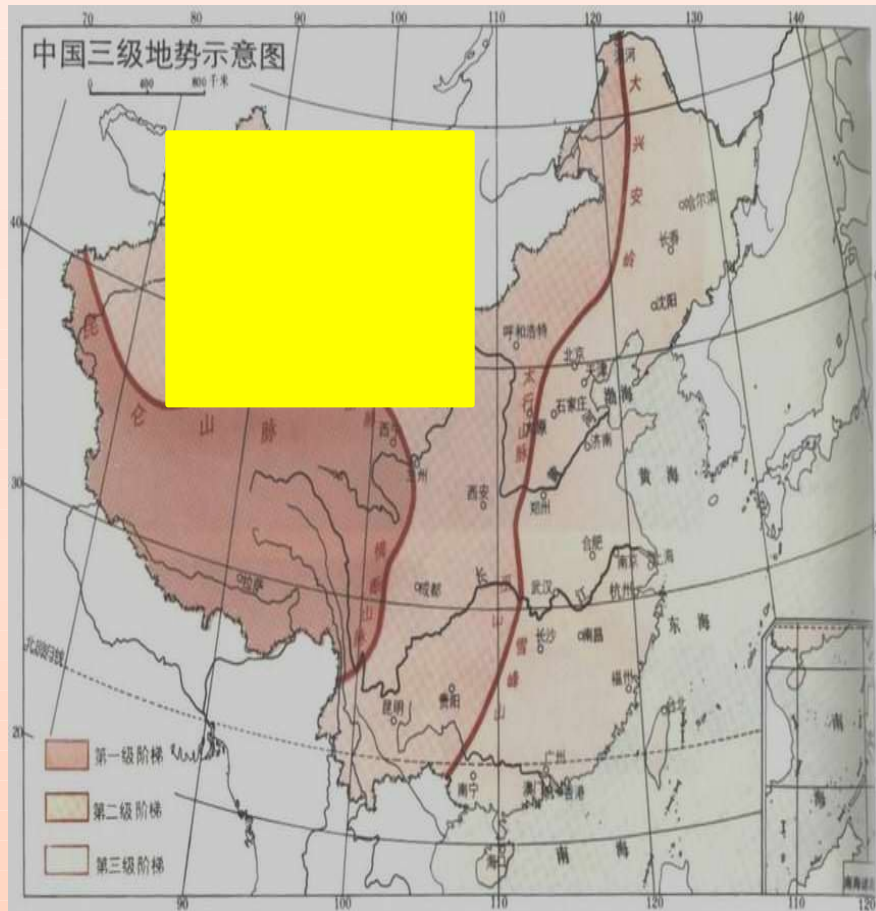

- Moist
- Vegetation
- Nomad people living nearby
- Aging, unstable face
- Reasonable climbing period
- Bitter winter



诺尔盖 LINHOF617 + 90 RVP100  
PHOTO BY WJUTU 2009.7

By 王巨士





blan du kou alpa+48 rvp100  
photo by wjtu 2009.7

By 王巨士





*xiang ri kui P67 + 5mc45 RVP 100  
photo by wjttu 2009.7*

By 王巨士



# Characterization of the climb

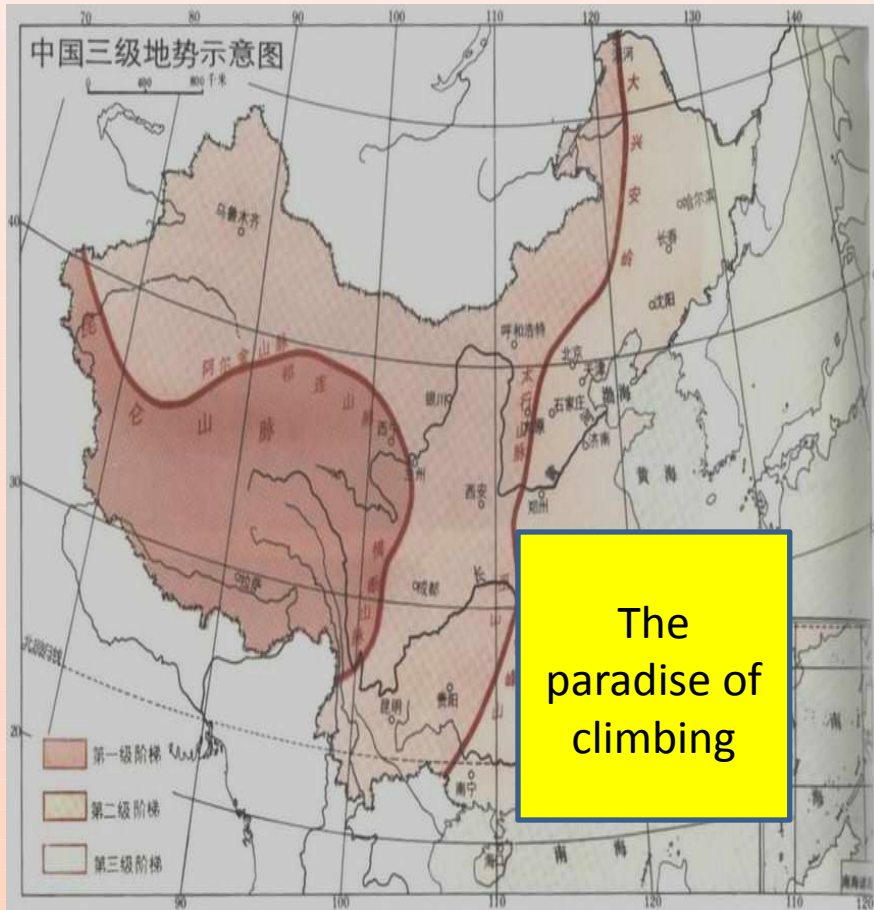

- Moist
- Vegetation
- Farming, hunting culture
- Aging, unstable face
- Big rock face
- Avalanche
- Reasonable climbing period



By 王巨士



四姑娘山 P67+SMC 200+2x RDP3  
photo by wjtu 2009.7

By 王巨士





四姑娘山 LINHOF617+250 KVP100  
photo by wjtu 2009.7

By 王巨士

XINLIYUHI P67+SMC700 R/P00  
photo by wjixdx 2009.7



By 王巨士





新路海冰川 LINHO617+280 KVP100  
photo by wjtu 2009.7

By 王巨士







理塘高原 P67+SMC 200 RVP100

photo by wjtu 2009.7

By 王巨士





阿日扎 ALPA12s+APO35 E100V3  
photo by wjutu 2009.7

By 王巨士





甲居的黎明 P67 + smc90 rvp100  
photo by wjutu 2009.7

By 王巨土





诺尔盖 LINHO617 + 90 RVP100  
photo by wjtu 2009.7

By 王巨士



瓦切 LINHO617 + 90 RVP100





By 王巨士





# The Tibetan





# 中国三级地势示意图

0 400 800 千米



乌鲁木齐

天天舞苑



# TIBET



天天舞苑

# Ice Climbing



# Ice Climbing

1. **Peach Heaven Valley, 2 hours from BJ**  
Water ice, WI 1-WI 6+ , a few dry-tooling  
(about 10 routes above WI 4)
2. **Yunmeng Valley, car 3 hours from BJ**  
WI4, long pitch, 150m
3. **The White River, car 2 hours from BJ**  
WI4+ M8
4. **Inner Mongolia, car 6 hours from BJ**  
WI5+



The most popular one,  
as crowd as Rumney

Beijing

NEPAL

BHUTAN

INDIA

BANGLADESH

Yunnan

BURMA

VIETNAM

LAOS

Bay of Bengal

East  
China Sea

Taiwan

South  
China Sea



# Peach Heaven Valley

WI4, 25m



PHOTO 紫笛依扬  
www.zidiyiyang.fr



The Needle, WI6, 10m+

ICE DAY

PHOTO 紫笛依扬  
www.zidiyiyang.fotoyard.com

# Ice Climbing

- Drew climber's attention back in early 2000s
- One of the best two ice climbing destinations in the whole world, Canadian Rockies and Double Bridge Valley (maybe the best?)
- From WI2---WI7, from 20m to 500m

“Canadian Rockies, hundreds of climbs, thousands of climbers; Double Bridge Valley, tens of climbs, thousands of climbers”

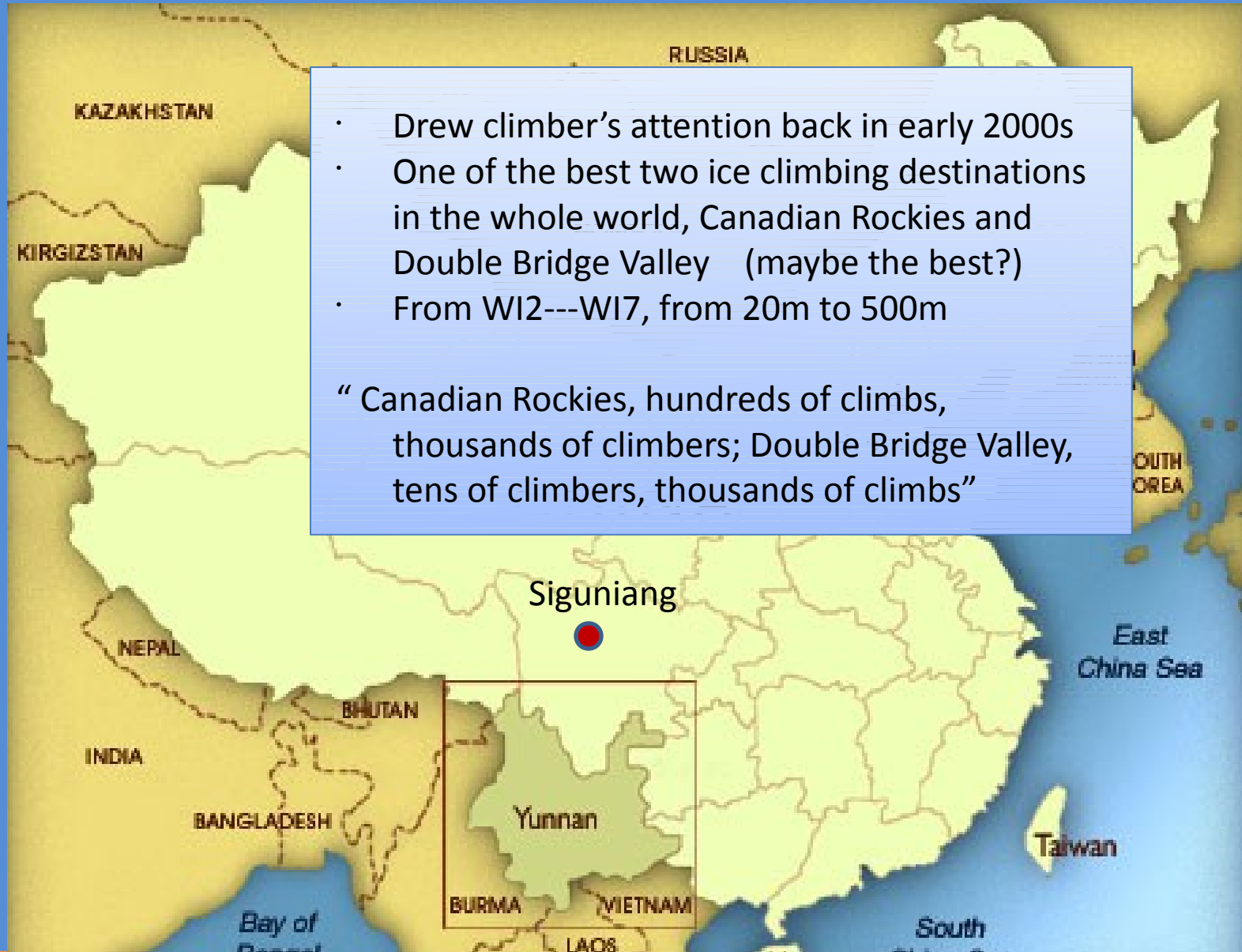



# Jesus's Robe, 30m+, W14+





Dragon Breath, WI6+, 2Pitches



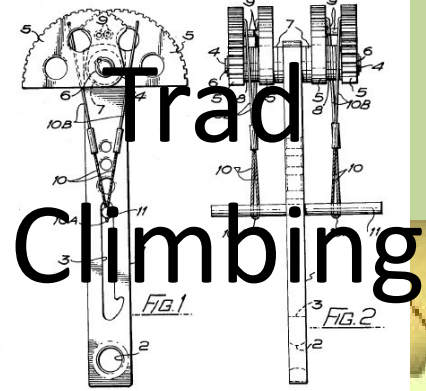

# Trad Climbing

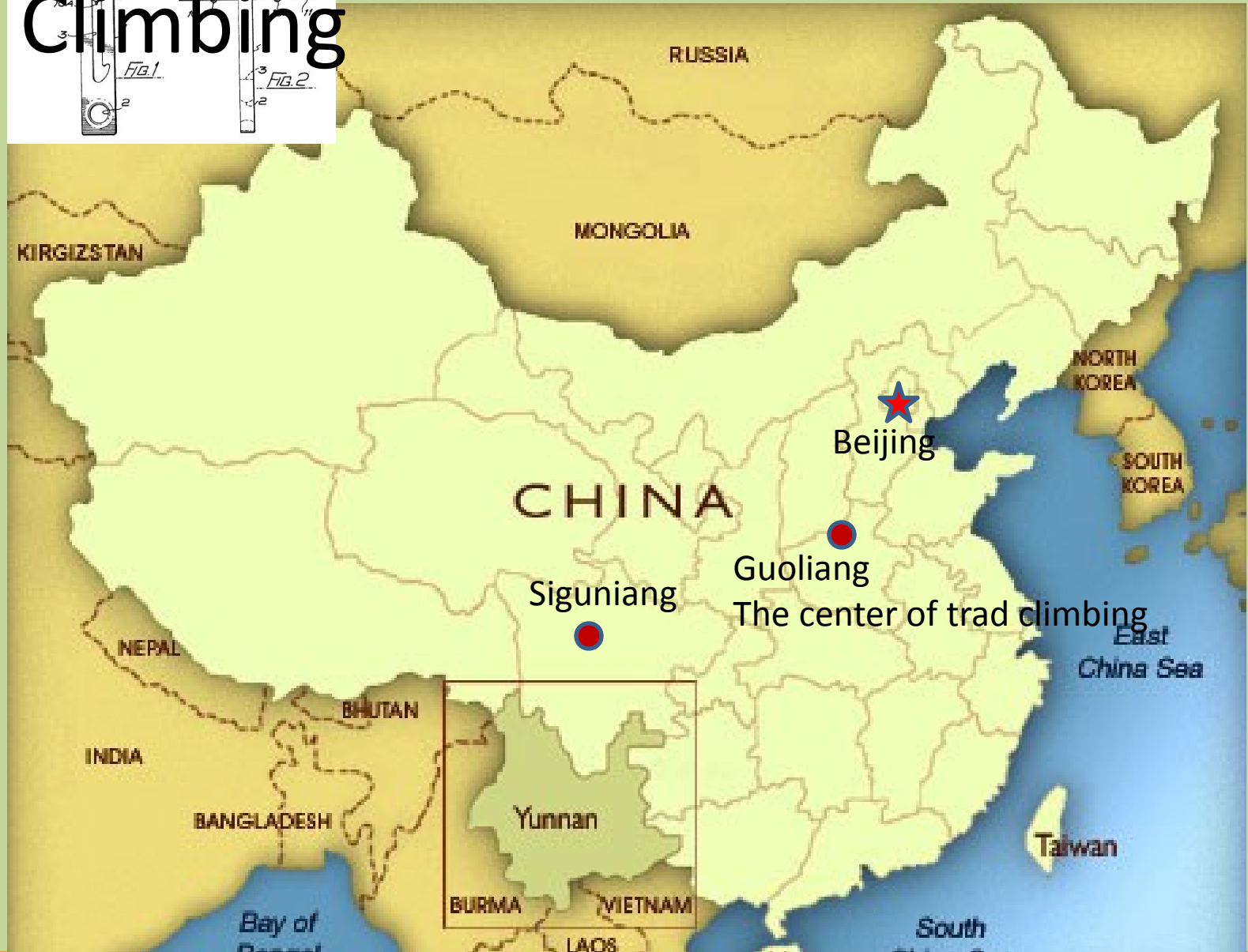





Memorizing Kristan 5.11b

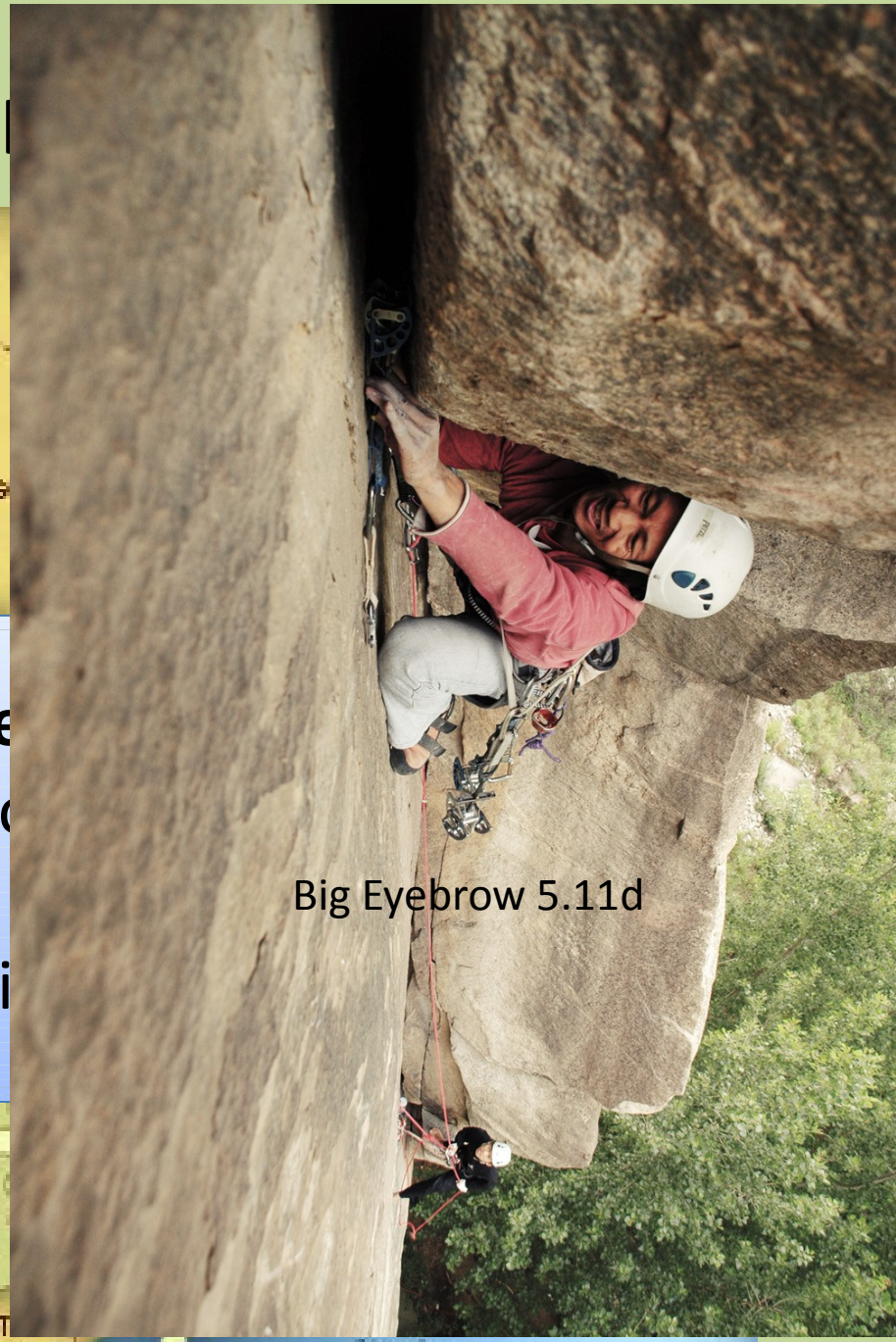

Big Eyebrow 5.11d



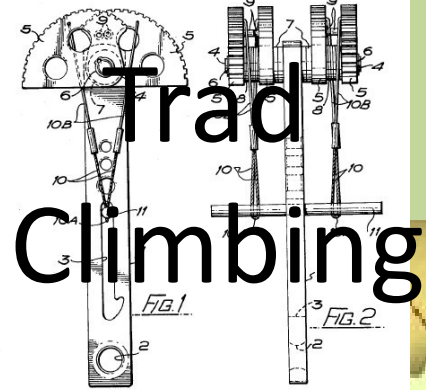

# Trad Climbing

- Chinese version of Gunks
- 4 hours from BJ
- 1 hour from Zhengzhou
- Hundreds of climb
- In park, have to buy ticket
- Quartz

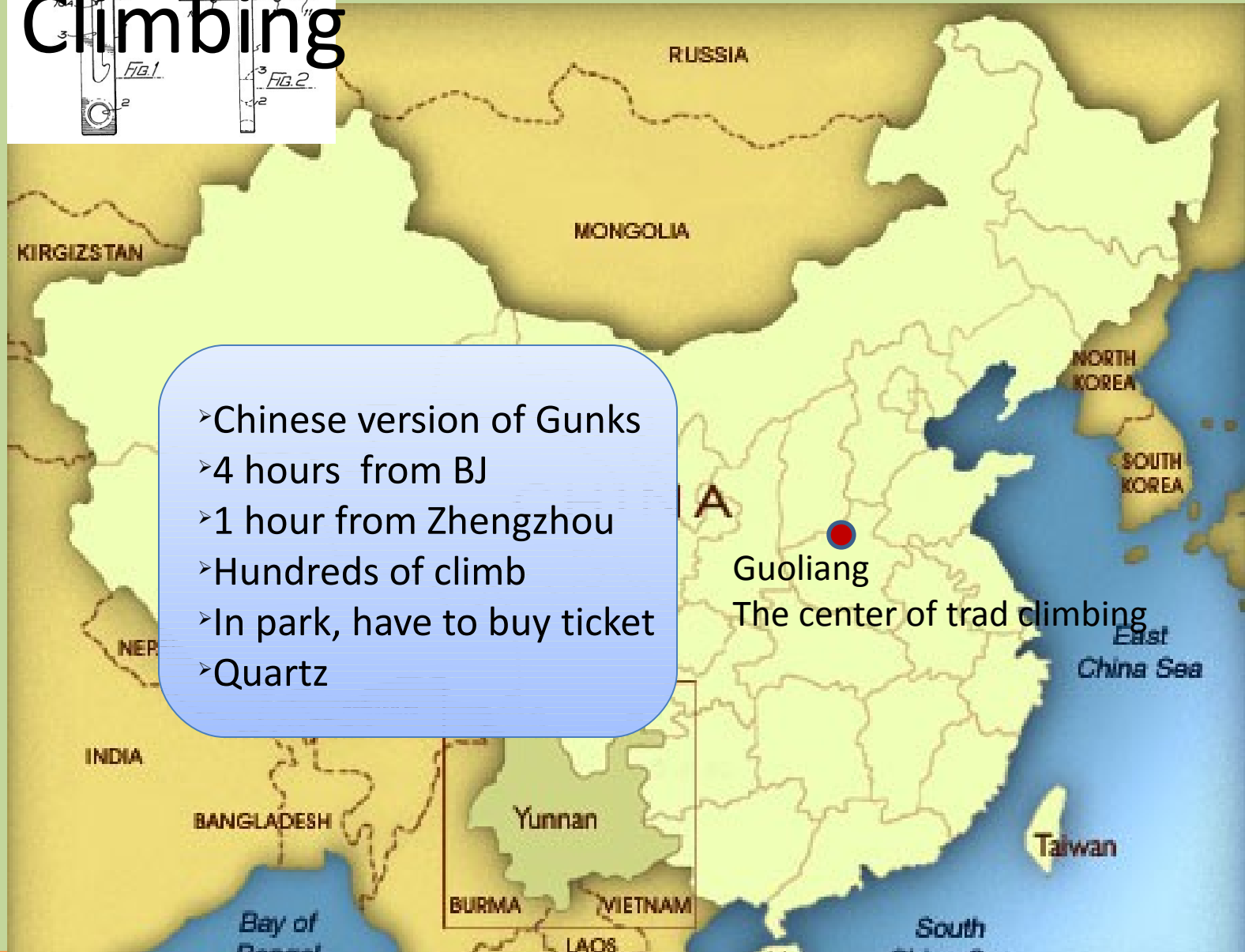









# ASCENT

THE SERIES

- GRAND PRIX OF THE CLIMBING FILM FESTIVAL
- GRAND PRIX OF THE CLIMBING FILM FESTIVAL
- GRAND PRIX OF THE CLIMBING FILM FESTIVAL
- GRAND PRIX OF THE CLIMBING FILM FESTIVAL
- GRAND PRIX OF THE CLIMBING FILM FESTIVAL
- GRAND PRIX OF THE CLIMBING FILM FESTIVAL

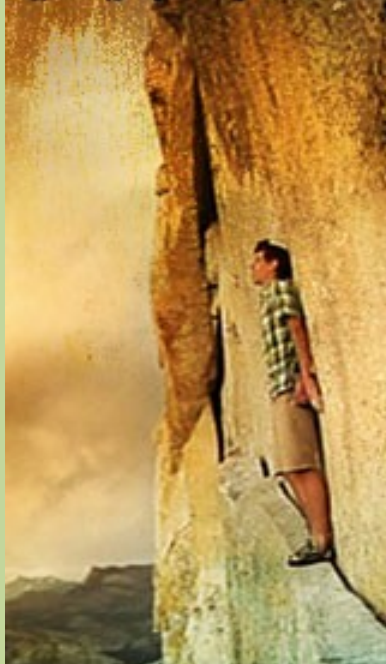

WATCH THE TRAILER

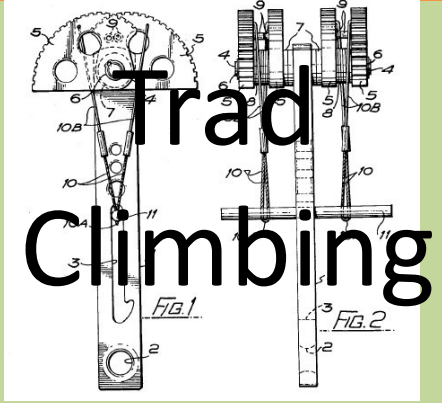

# Trad Climbing





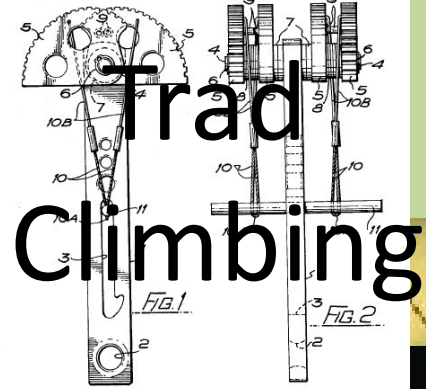

# Trad Climbing

RUSSIA

KIRG



# Shaolin Temple

FreeFoto.com

Bay of Bengal

BURMA

LAOS

VIETNAM

South China Sea

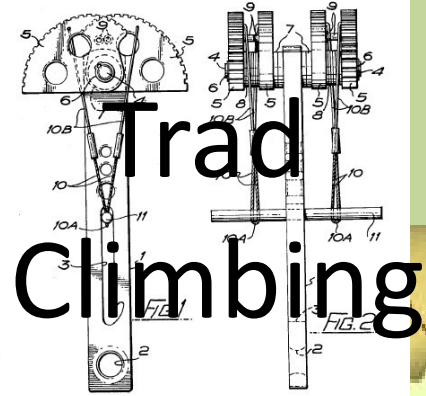

Big wall, Siguniang area  
Granite



Free Elevator, 24 pitches, 5.10



# South Face of “The Second Sister”, 12 pitches, 5.11+





# Sport Climbing

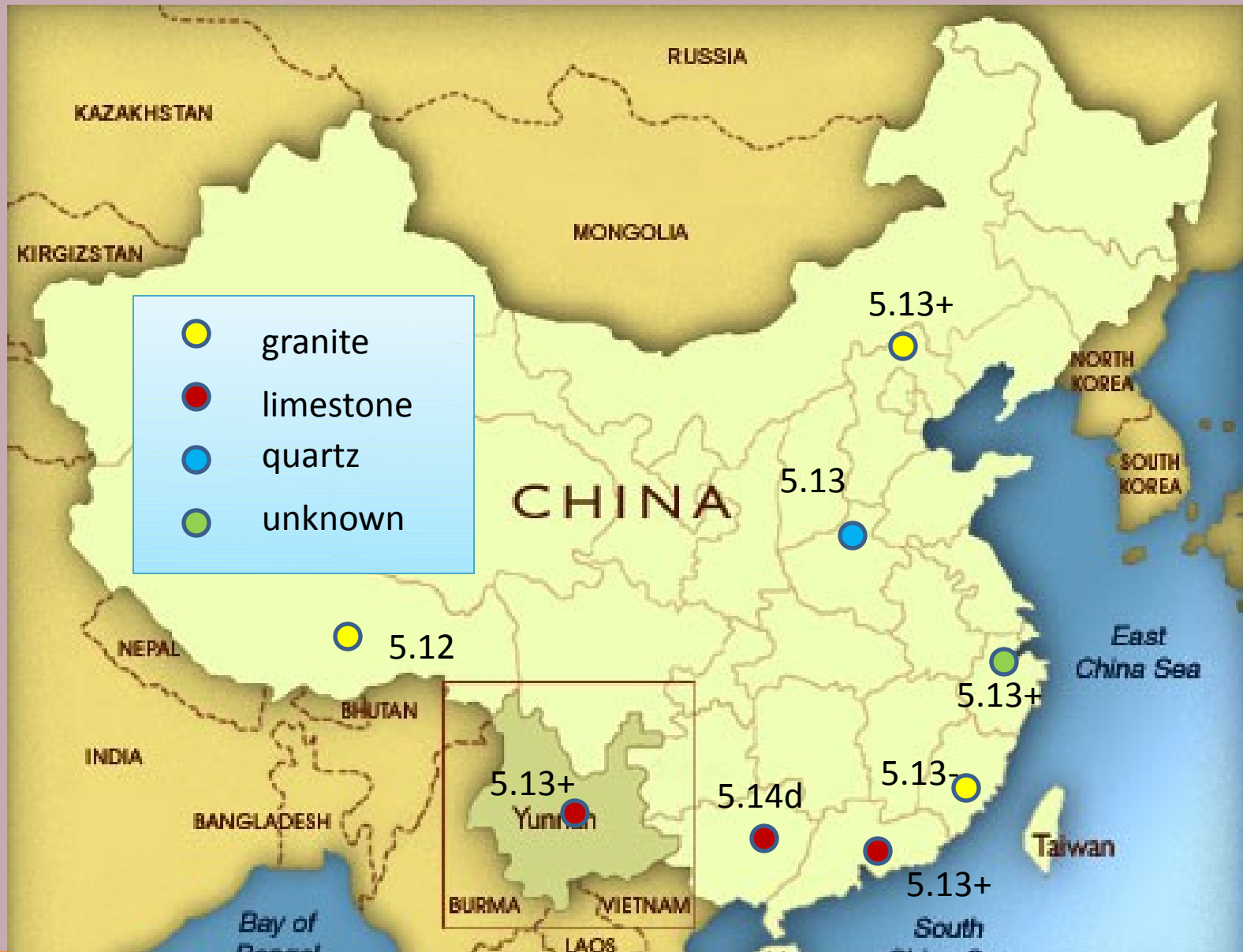

# Yangshuo

- ❖ It has everything in terms of “bolt” culture, along with deep water soloing
- ❖ Relative long single pitch
- ❖ Some multipitches
- ❖ Good accomodation
- ❖ Good traffic
- ❖ Climbing Season, all year
- ❖ It also offers kayaking, caving, (even language program, part time job)



# The White Mountain Crag

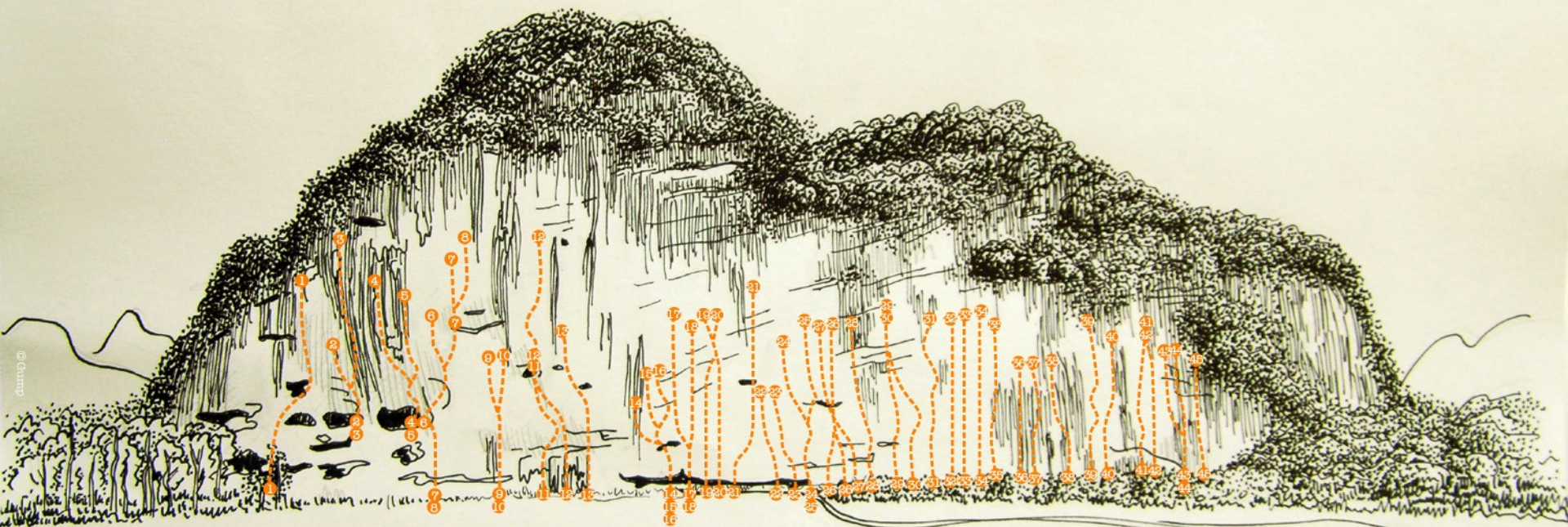

## White Mountain Crag

1. The Tale of the Talus, 7a+, 40m, Seb Grievie, 2006
2. Blue Magic, 8b+, 16m, French Nike Team ACG, 2007
3. Gullin Rice Noodles, Project, 30m, Chris Sharma, 2009
4. Spicy Noodles, 8c+, 27m, Chris Sharma, 2009
5. The Axeman, 8a, 27m, Neil Gresham, 2007
6. China Climb, 8c, 22m, 刘永平, 2008
7. Spanish Route, Project, 40m, 2010
8. Spanish Route, Project, 48m, 2010
9. Unnamed, 7c+, 22m, Gerome Pourveau, 谢街成, Early 2005
10. Unnamed, 7c+, 22m, Gerome Pourveau, 谢街成, Early 2005

11. Unnamed, 7a, 20m, Gerome Pourveau, 谢街成, Early 2005
12. Aiding & Abetting, 6c+, 20m, James Murphy, Paul Collis, 2004
13. 2 American/Franch Gangstar, 8c, 22m, French Nike Team ACG, 2007
14. Korea No.1, 8a, 23m, J.H. Kim, 2008
15. The Big Sun, 6c, 16m, Simone Liu, 2006
16. Two in the Pink, One in the Sink, 7b, 20m, Dave, 2008
17. China White, 7b, 20m, Seb Grievie, 2005
18. Qin & Tonic, 6a+, 30m, 谢街成, 2007
19. TsingTao Beer, 7c+, 23m, Shinsuke Kimura, Rie Kimura, 2006
20. Gung of Four, 7c, 29m, Mark Garthwaite, 2005
21. White Devil, 7c, 29m, Neil Gresham, 2005
22. YangShuo Hotel, 7b, 34m, Shinsuke Kimura, 2007

23. Fire Bird, 6c, 14m, Rie Kimura, Shinsuke Kimura, 2006
24. The Missing Link, 6a+, 15m, Paul Collis, 2004
25. The Wall of Attrition, 6c+, 23m, Paul Collis, 谢街成, 2004
26. Cave Man, 6b+, 26m, Paul Collis, 谢街成, 刘清, 2004
27. Unnamed, 7b, 26m, 2009
28. West Streak, 7a+, 27m, Grant Farquhar, 2005
29. Lucky Zone, 7b+, 26m, Soichiro Fukuda, 2007
30. Devil Shocks, 7b, 27m, 刘春雨, 谢街成, 2005
31. The Stone Dog, 6a+, 27m, Paul Collis, Dingo, Lao Gan Ma, 2004
32. 匪徒逆袭, 6c+, 27m, Torsten Geddoke, Susann Hantecho, Elke Schmitz, 2006
33. The Phonexix, 7b+, 27m, Colton Lindeman, 2006
34. The Tic Tac Smuggler, 7c, 28m, Colton Lindeman, 2006

35. Psoe Route, 6b+, 50m, Paul Collis, James Murphy, 2004
36. Merry Christmas, 6c, 27m, Zao & Kasia Pisetzky, 2005
37. Happy Chanukah, 7b, 24m, Zao & Kasia Pisetzky, 2005
38. Unnamed, 7c, 23m, 西屠, 2007
39. Captain Debauchery, 6c+, 24m, Solly Fernandez, 2006
40. The Comedians, 6a+, 27m, Mike Robertson, 2006
41. Girl With a Machete, 25m, 7a, Joe Picalli, 2006
42. Slippery Nipple, 7c+, 25m, Colton Lindeman, 2005
43. Abnormal, 6c, 25m, Colton Lindeman, Abi Roberts, 2008
44. 两把刷子, 6a, 22m, Bob Kesty, Paul Collis, Ton Ton, 2008
45. 橘子花春, 5+, 22m, Ton Ton, Paul Collis, Bob Kesty, 2008
46. The Prowl, 6a, 23m, Andrew Christensen, 2007



5.14d Spicy dumplings





# The Moon Hill

5.11-5.14a

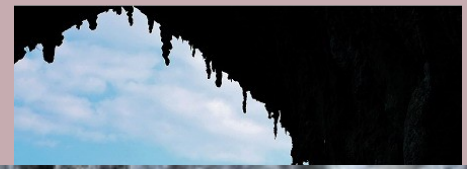

PHOTOGRAPHER:ROCKER

[bbs.rock-lizard.org](http://bbs.rock-lizard.org)

# Bouldering





# Bouldering



- Detailed guide info
- Close to big city
- Beach view
- An excuse to get drunk





By Wang Zeng





By Wang Zeng

By Wang Zeng

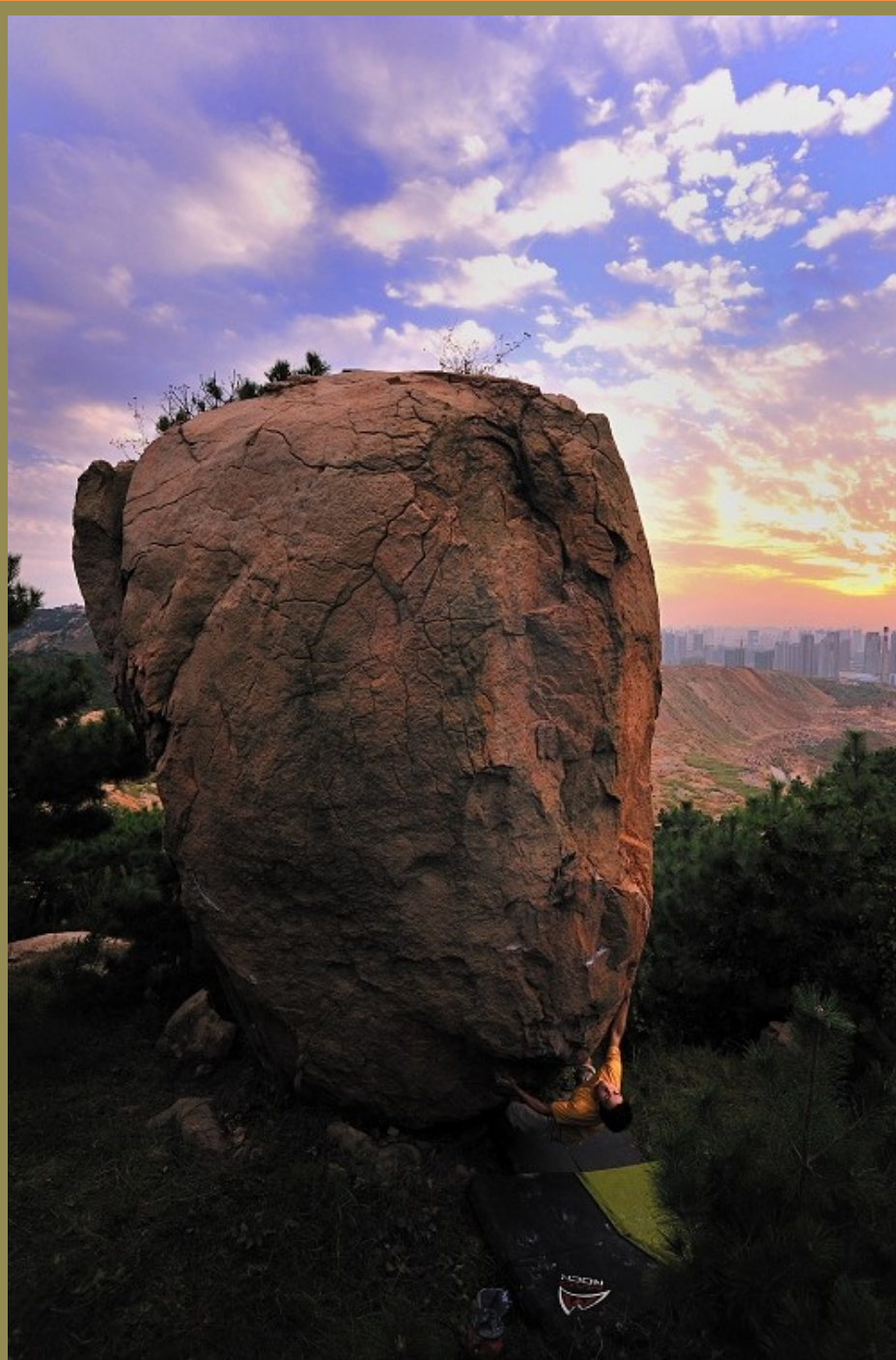





By Wang Zeng



By Wang Zeng





By Wang Zeng

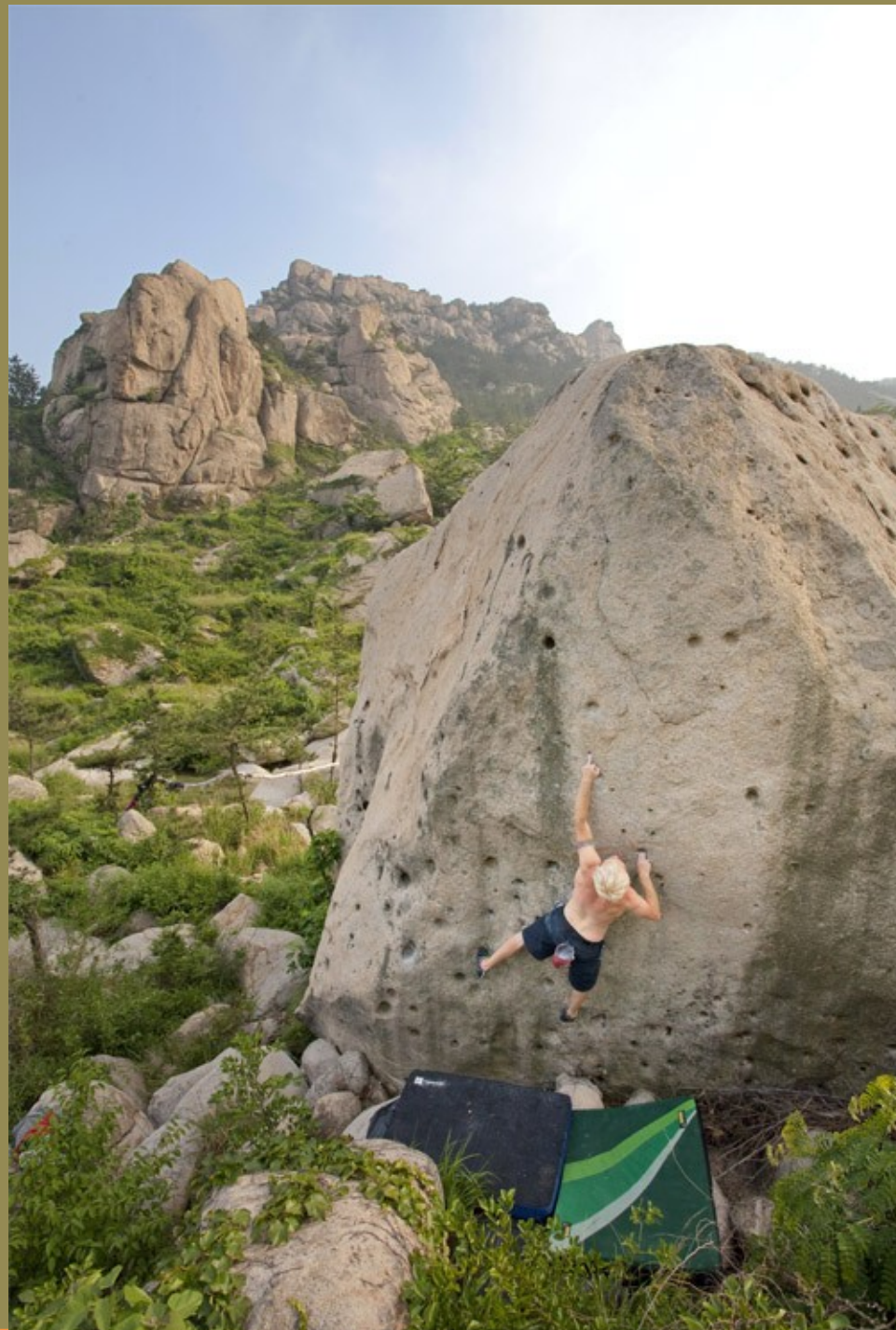

By Wang Zeng





By Wang Zeng



By Wang Zeng



Sweating ?



# Bouldering

Human activity destroyed the ecological system. Deserted since late 20th century.





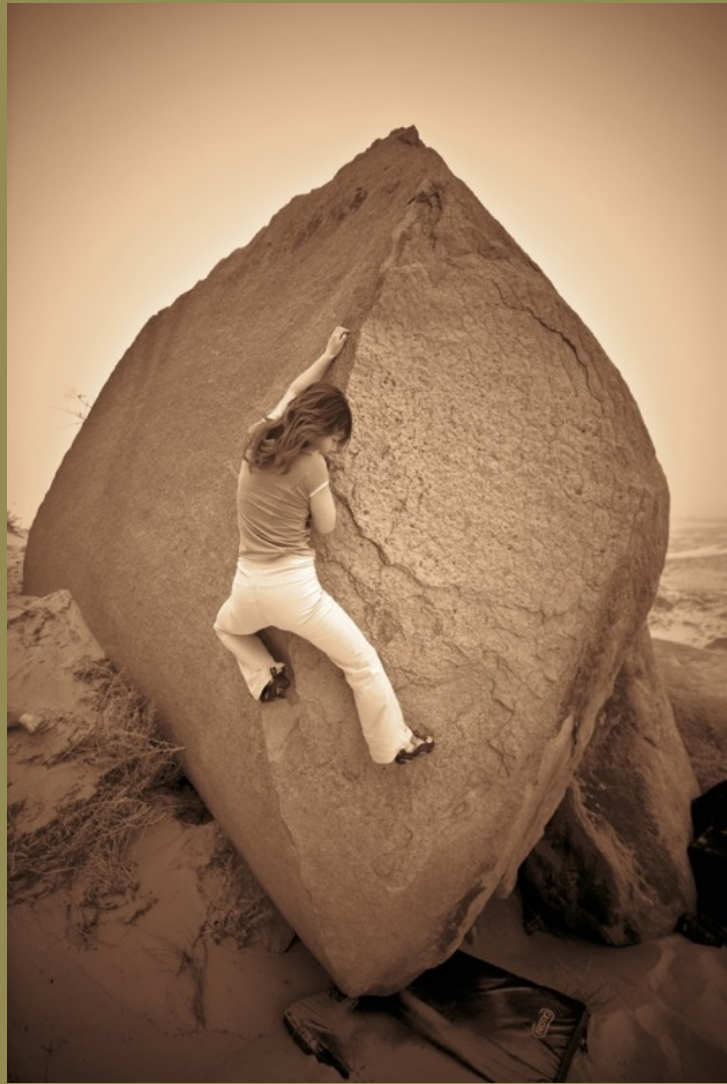

By Alex

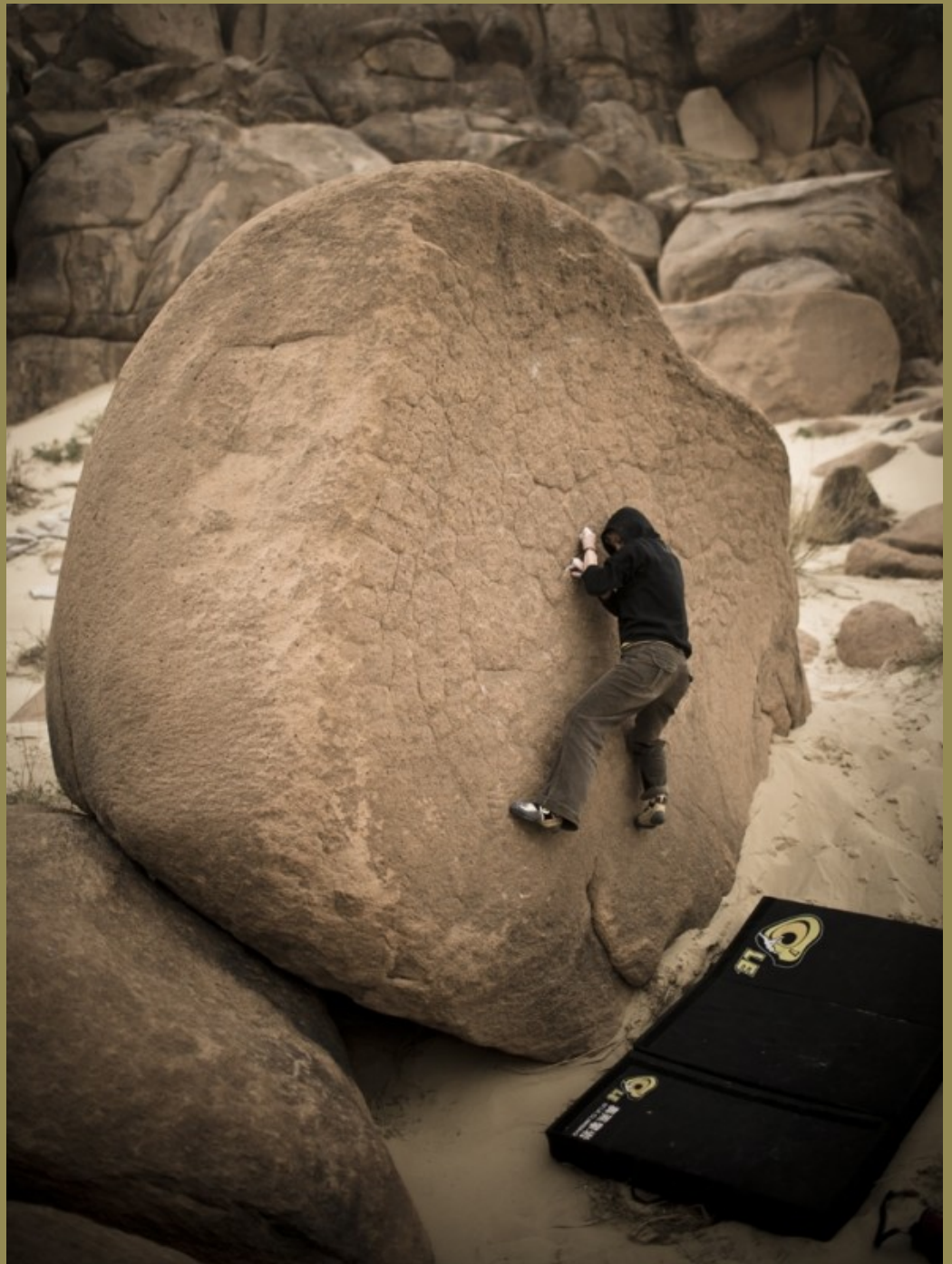



By Alex





By Alex



# Destination with strong climbing culture

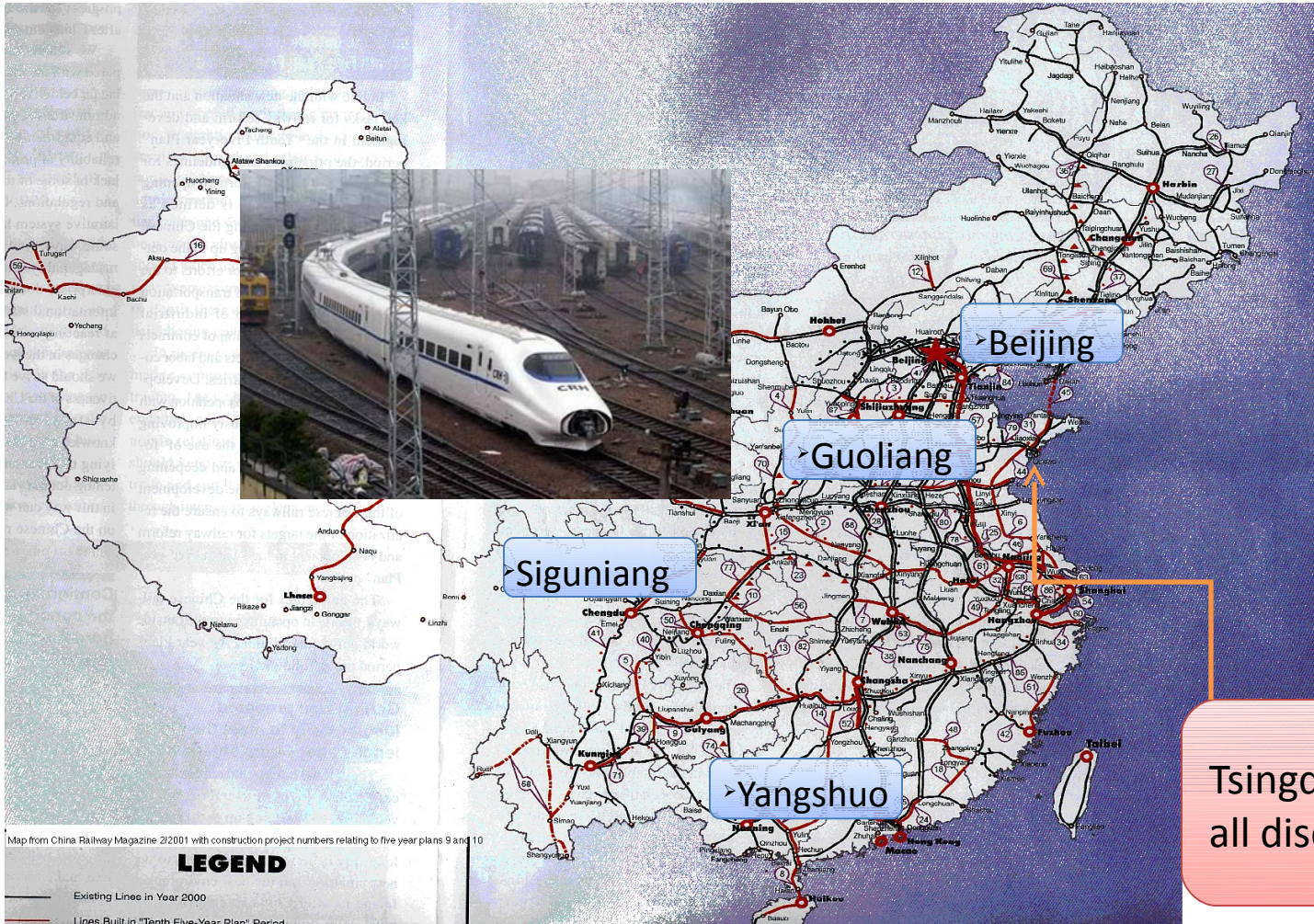



# Abundant Resources

New crags and blouders are found everyday

Depend on

- climbers' perspective
- depend on climber population
- property rights

# Review of new climbs established in recent 8 months



Guizhou

Oct 2010- Apr2011

Petzl Rock Trip , Oct 2011





© PETZL - E. Lelann



250+ lines  
9a+/5.15a grade

# Review of new climbs established in recent 8 months



Guizhou  
Oct 2010- Apr2011  
Petzl Rock Trip , Oct 2011

Leye, Guangxi  
Bolting leader, Achen  
Jan, 2011





Hundreds of routes  
5.8-5.14

Achen started the project.



# Review of new climbs established in recent 8 months

Guizhou  
Oct 2010- Apr2011  
Petzl Rock Trip , Oct 2011

Xinchang  
Oct 2010- now  
Sport, bouldering, trad

Leye, Guangxi  
Bolting leader, Achen  
Jan, 2011







30 routes, from 5.8-5.12

**By Shanghai climber community**

# Review of new climbs established in recent 8 months



Xinjiang  
Tommy Caldwell's crew  
rock scramblin' explorations  
Sep, 2010

Guizhou  
Oct 2010- Apr2011  
Petzl Rock Trip , Oct 2011

Xinchang  
Oct 2010- now  
Sport, bouldering, trad

Leye, Guangxi  
Bolting leader, Achen  
Jan, 2011



Established several 5.11+







ge,

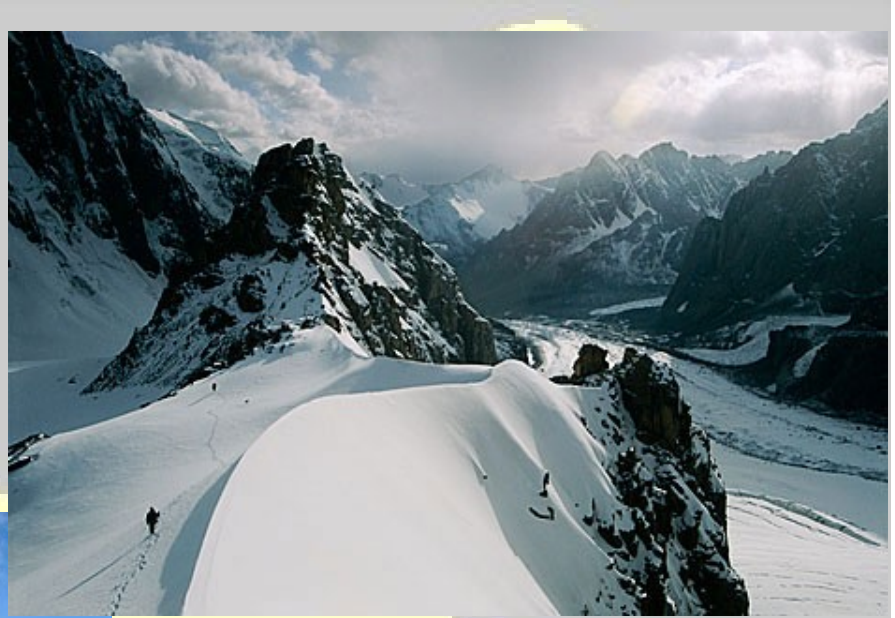

Back to 2000

# Jerry Dodrill





# Promising, but.....

Due to the independent nature of climbing in Kunming and the many years of effort on part of the local climbers here, the Redpoint Club has a very different perspective on climbing in Yunnan and how and when to advertise our efforts. **We really don't want a "Yangshuo Two"** with tens of different guiding companies competing for business and scores of climber tourists crowding every crag.

---Hanna Waight forwards the letter from W2  
2011



# My Trips

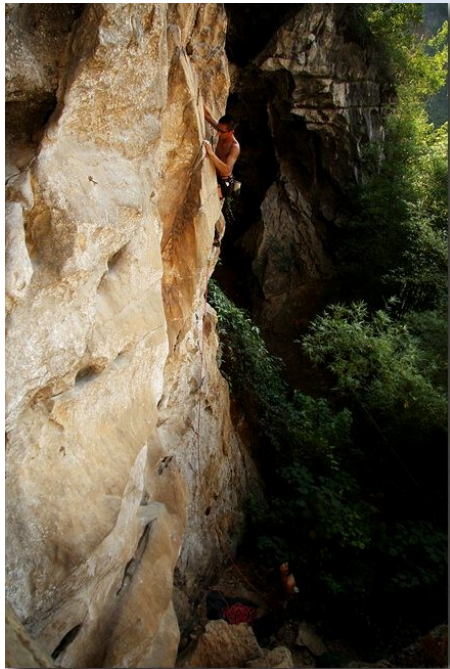



# CHINA



Himalaya Style multi days fixed camps  
Alpine Style limited days moving camp

4 hours to town,  
1 hour to valley

# Gangshka

5254.5m

Xining

Lanzhou

Beijing

One day by train,  
3 hours by flight

Shanghai

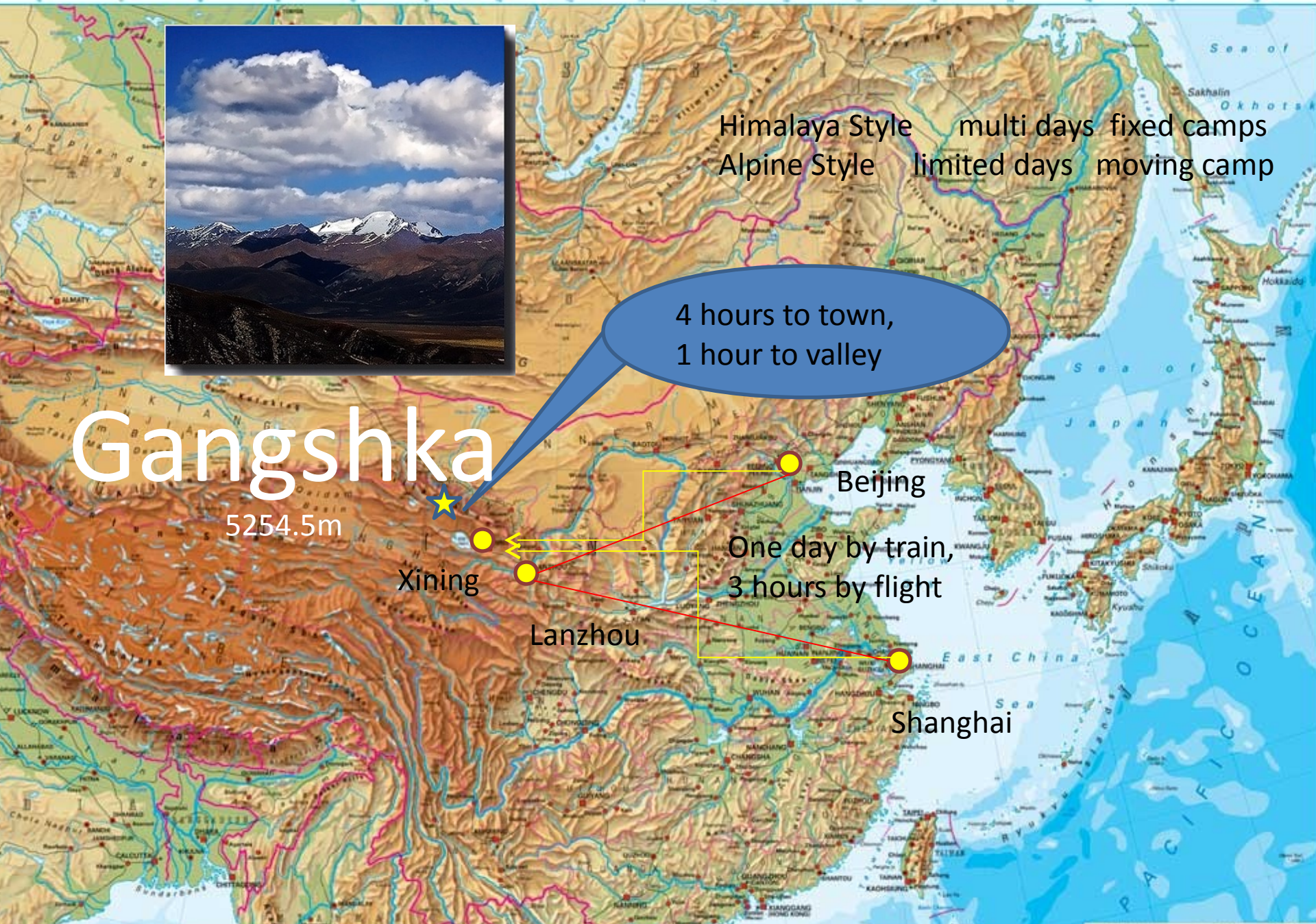





3-4 hours  
Trekking on loose face









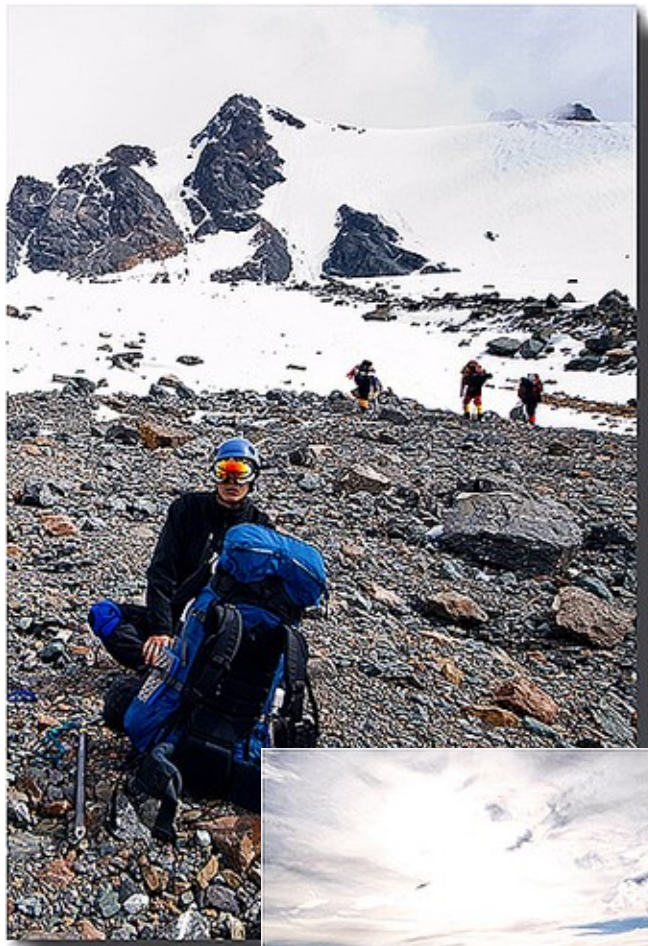



WI 2

The final face, 14 pitches , 600m







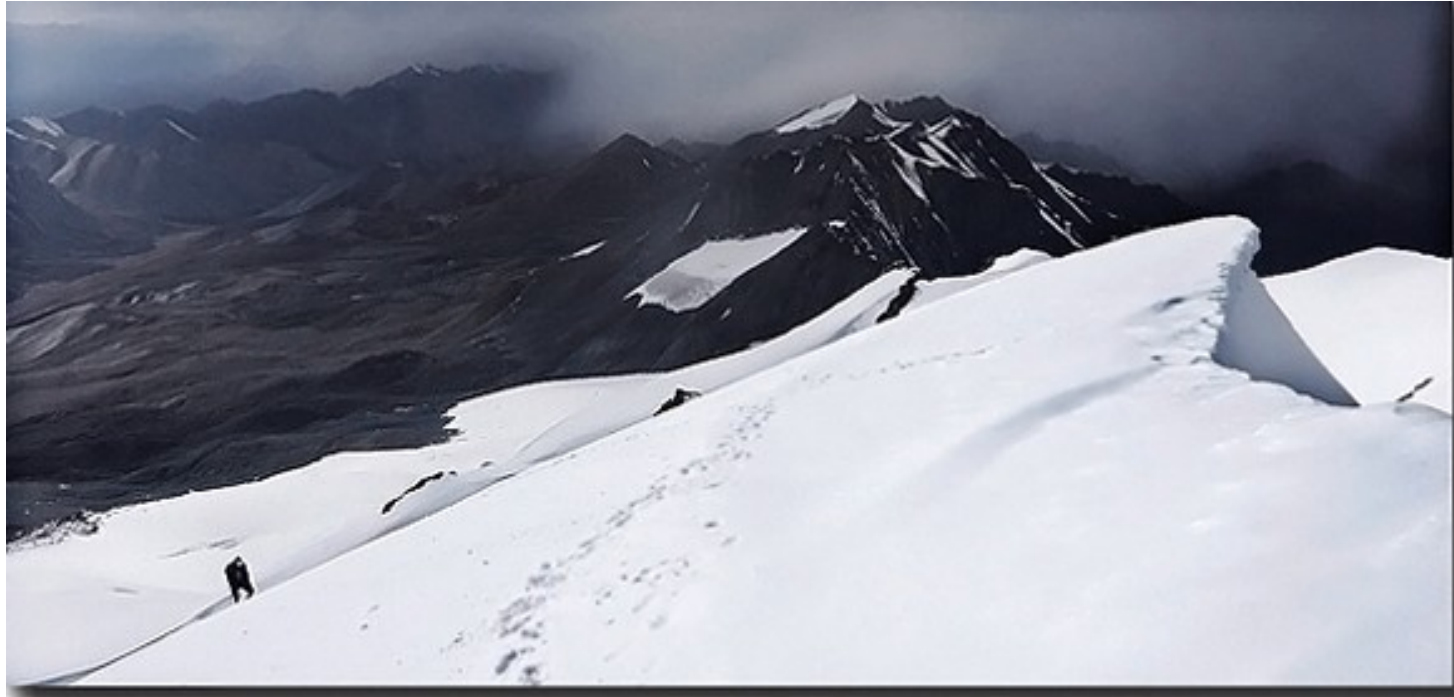

Summit





Late return  
Storm  
About 38 hour no food





# Gangshka

- Accessible
- Moderate terrain
- Easy technical ice climbing, glacier roping operation

A good bet for entry-level real alpinism  
(Vegetarian will have a bit trouble there)

# CHINA



Chola

6168m



Chengdu





# Ouch!!

Hard to access  
Unfriendly

Entrance 380

Trekking  
Cross icy lake  
4 hours

Camp 4500m

Advance

Camp 1  
Deep snow/  
WI3 ice clim  
10 hours +

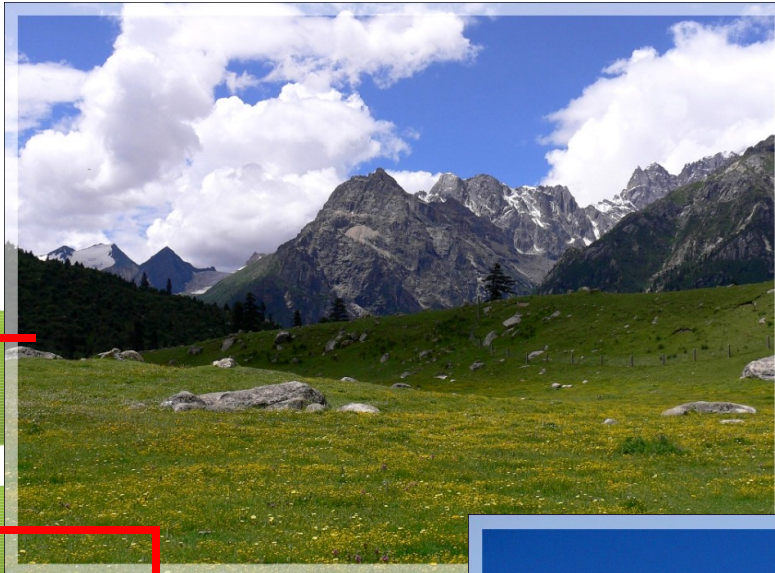

4





T  
C  
4

## Base Camp 4500m

Loose rocks  
brutal elevation

Partial 5.7-5.8 rock  
7 hours

## Advanced Based Camp

Dangerous ch  
Rope operati  
WI2+ ice clim  
8-10 hours

## Camp 1 5160m

Deep snow/ powder in the afternoon  
WI3 ice climbing  
10 hours +







T  
C  
4

# Base Camp 4500m

Loose rocks  
brutal elevation

Partial 5.7-5.8 rock  
7 hours



# Advanced Base Camp



C  
De  
W  
10

s ch  
ati  
lim  
s  
oon



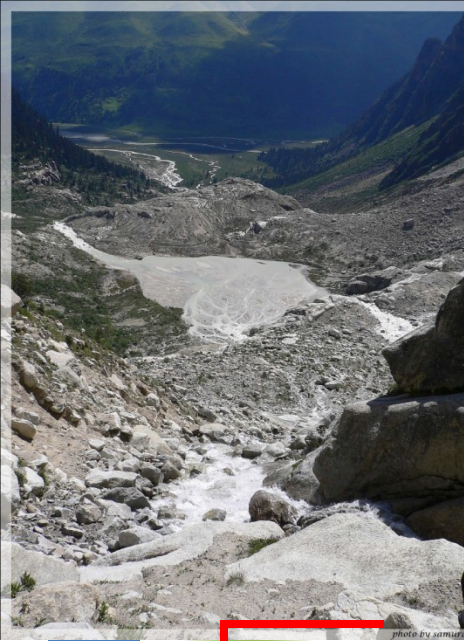

T  
C  
4

# Base Camp 4500m

Loose rocks  
brutal elevation

Partial 5.7-5.8 rock  
7 hours



# Advanced Base Camp



C  
De  
W  
10

s ch  
ati  
lim  
s  
oon

photo by samurai  
photo by samurai





Dangerous crack zone  
Rope operation  
WI2+ ice climbing  
**8-10 hours**

*photo by zenith*

Advanced Base Camp

4950m

**Crack Zone, Tricky**

5160m  
powder in the afternoon  
WI3 ice climbing  
10 hours +





*photo by zenith*



*photo by zenith*



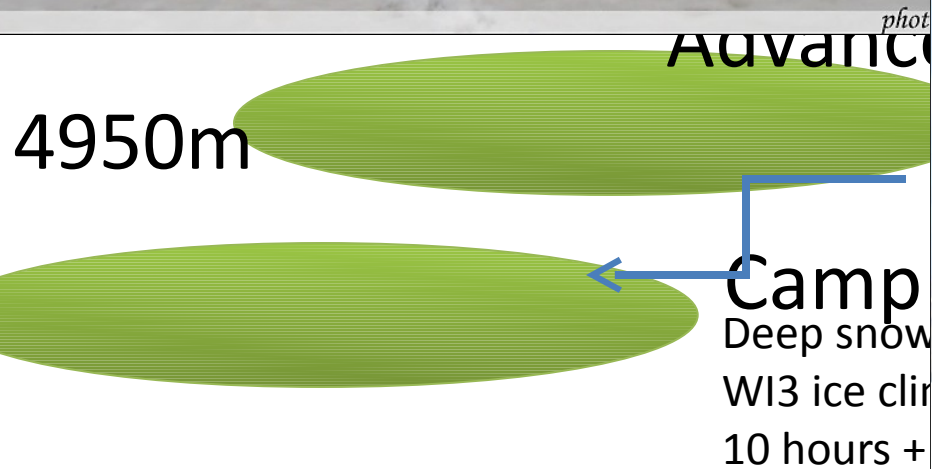
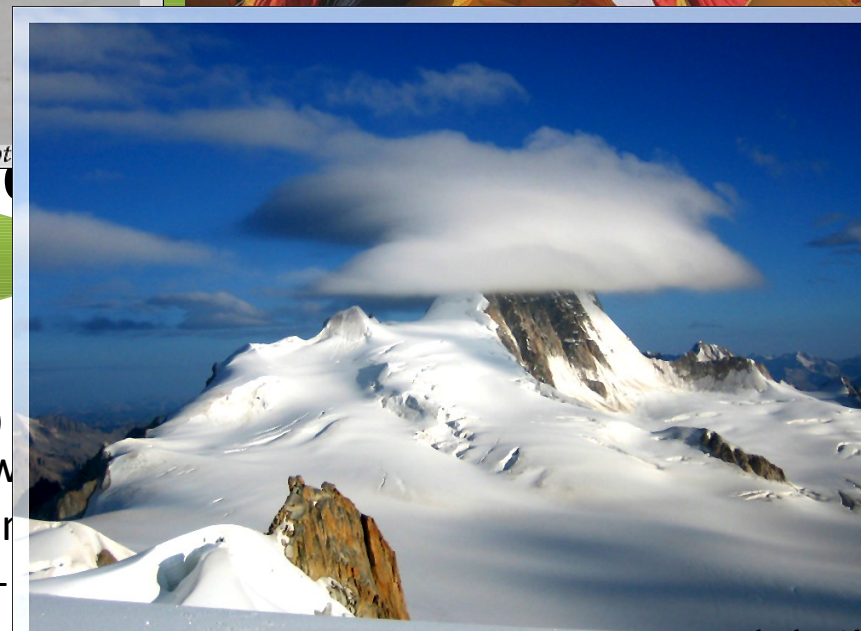



photo by zenith

Trek  
Cross  
4 hours



photo by zenith

4

Base Camp 4500m

Block



photo by zenith



photo by zenith

5160m

12 hours





photo by zenith



photo by zenith

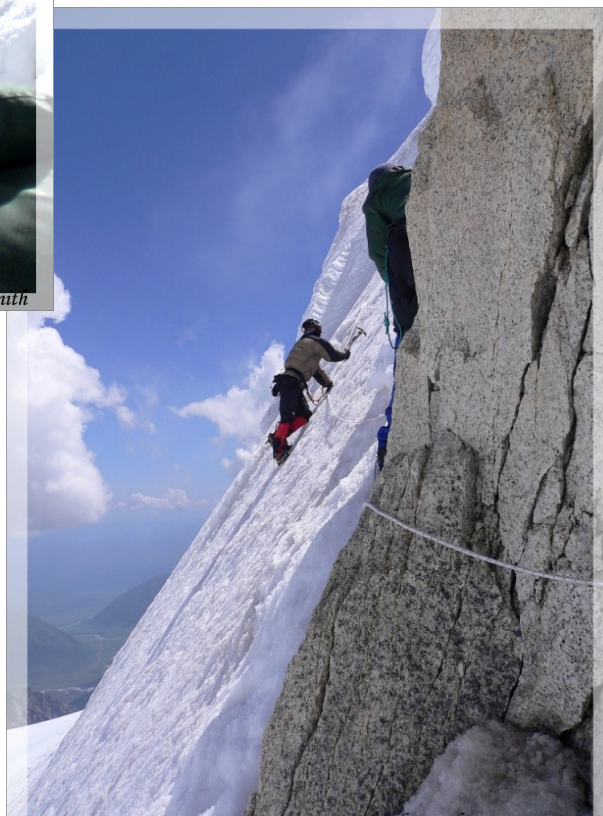

photo by samurai



photo by zc



photo by zenith

www.alpinist.cn

# 山野 ALPINIST

中国登山协会主办

白河国际攀岩大会  
高山向导:风雪人生路  
世界第一高峰测距回顾  
2006年中国青海高原世界杯攀岩赛

定价:RMB 11.00元 邮费:0.80元  
ISSN 1001-974X

9 771001 974065

2006/09

邮发代号:1-107 零售:0.80元 邮费:0.80元 邮发代号:10-122



# Summary & Dilemmas

- ❖ In-system management, CMA



- ❖ The unclear property rights, the vague laws, abuse of power

- ❖ Preservation V.S. Exploration

- ❖ Health care, income, values in climber community



中国三级地势示意图

不知道 --- Boo Gee  
Dau

Do not understand

没有钱 --- May You Chain

Have no money

Skip Tibet

Smile!

Climb Hard  
Behave Smart

- 第一级阶梯
- 第二级阶梯
- 第三级阶梯

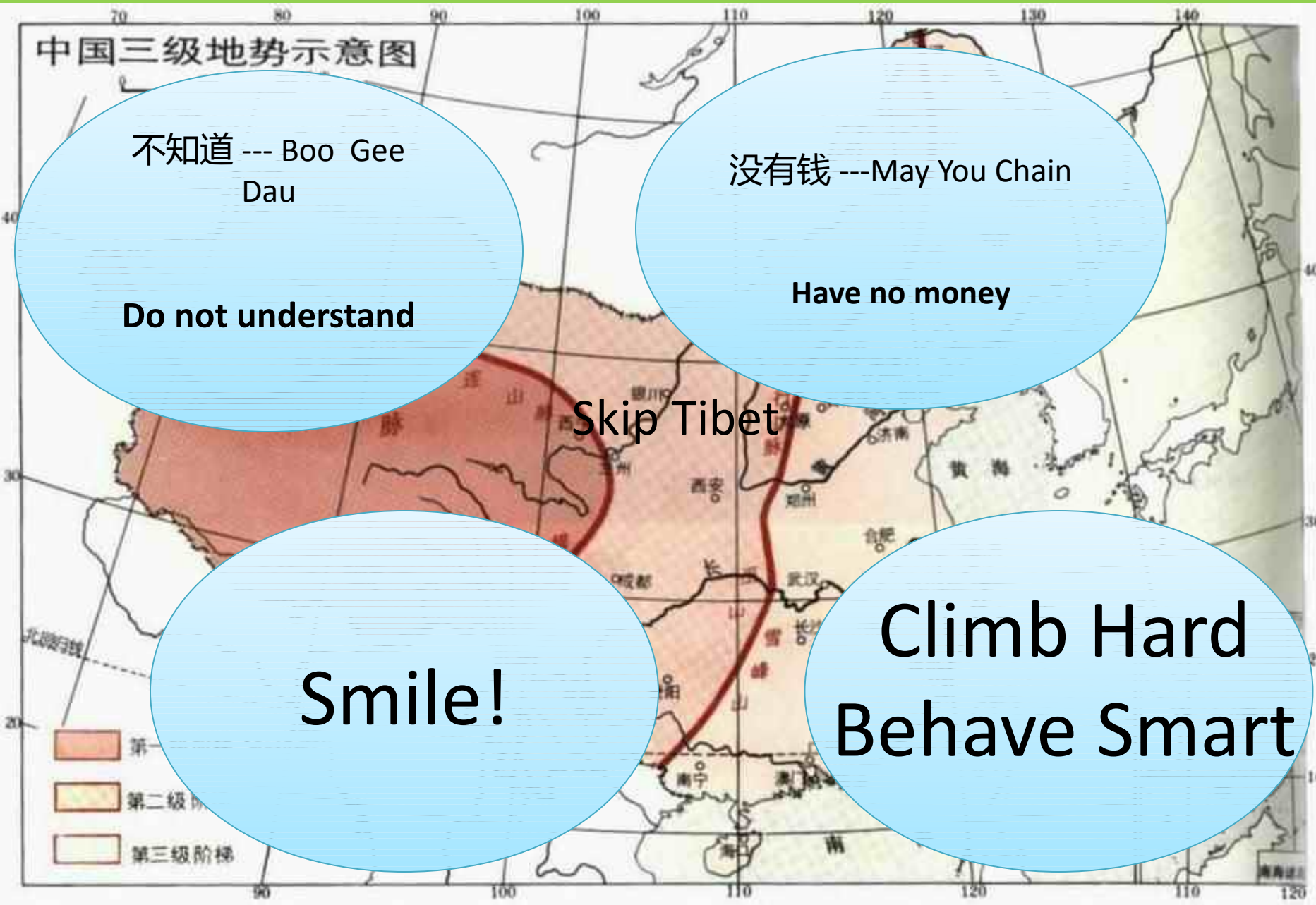

**Thank You**